

En **AUTOPARTES**
nuestro respaldo,
su tranquilidad.



**MANGUERAS
& RACORES**



www.asam.com.co

RACORES



En **AUTOPARTES**
nuestro respaldo,
su tranquilidad.





En **AUTOPARTES**
nuestro respaldo, su tranquilidad.

CATÁLOGO DE PRODUCTOS

**CESAR
FAJARDO**

CEL: 310 814 8858
TEL: 742 5422 EXT. 102
@comercial@asam.com.co

























**FREDDY
MONTEALEGRE**

CEL: 310 850 7384
@comercial3@asam.com.co

**JUAN DIEGO
GONZALEZ**

CEL: 310 858 6257
@comercial1@asam.com.co

Trv. 42 (AV. Ferrocarril) No. 9 - 70 - PBX: (57 - 1) 7425422
gerencia@asam.com.co - www.asam.com.co - Bogotá - Colombia

	PRECIO \$ 3.450		PRECIO \$ 2.900		PRECIO \$ 3.450		PRECIO \$ 2.900
Código 14-MA-01 14-MA-08 / 30-004	Descripción Machete largo Renault - 3/8" 24 NF x 55mm	Código 14-MA-02	Descripción Machete corto Renault - 3/8" 24 NF x 41mm	Código 14-MA-03 30-001 / 30-003	Descripción Hembra Con Ombbligo Renault 3/8" - 24 NF x 37mm	Código 14-MA-04 30-012 / 30-343	Descripción Machete Renault - 10mm (paso 1.0) x 40mm
	PRECIO \$ 3.450		PRECIO \$ 3.450		PRECIO \$ 3.450		PRECIO \$ 3.250
Código 14-MA-05	Descripción Hembra sin Ombbligo Renault - 10mm (paso 1.0) x 38.5mm	Código 14-MA-06 30-014	Descripción Hembra Estriada sin Ombbligo Renault - 10mm (paso 1.0) x 37mm	Código 14-MA-07	Descripción Hembra Pin 12mm sin Ombbligo Volkswagen - 10mm (paso 1.0)	Código 14-MA-09 30-011	Descripción Hembra Con Ombbligo Chev. Chevette - 10mm (paso 1.0) x 44.5mm
	PRECIO \$ 3.250		PRECIO \$ 3.450		PRECIO \$ 2.900		PRECIO \$ 4.800
Código 14-MA-10 30-058	Descripción Hembra sin Ombbligo Chev. Chevette - 10mm (paso 1.0) x 45.5mm	Código 14-MA-11 30-010	Descripción Hembra sin Ombbligo Fiat 10mm (paso 1.25) x 39mm	Código 14-MA-12 30-055	Descripción Machete Fiat - 10mm (paso 1.25) x 39mm	Código 14-MA-13 30-029 / 30-274	Descripción Ojo y Gancho Corto Mazda - Ø 10mm
	PRECIO \$ 3.450		PRECIO \$ 3.450		PRECIO \$ 4.450		PRECIO \$ 4.200
Código 14-MA-14 30-025	Descripción Huevo Pasante Redondo Mazda x 34.5mm	Código 14-MA-15 30-026	Descripción Hembra Con Ombbligo Mazda - 10mm (paso 1.0) x 34.5mm	Código 14-MA-16 30-068	Descripción Ojo Corto Chevrolet Sprint - Ø 10mm	Código 14-MA-17 30-050 / 30-287	Descripción Ojo Largo Suzuki - Ø 10mm
	PRECIO \$ 4.200		PRECIO \$ 3.650		PRECIO \$ 3.450		PRECIO \$ 3.450
Código 14-MA-18 30-033	Descripción Ojo Largo Curvo Chevrolet Swift - Ø 10mm	Código 14-MA-19	Descripción Hembra Con Ombbligo Chevrolet Luv 2300 - 10mm (Paso 1.0) x 34mm	Código 14-MA-20 30-034	Descripción Huevo Pasante Chevrolet Luv 2300 x 34mm	Código 14-MA-21 30-040	Descripción Hembra Hexagonal con Ombbligo Mazda Embrague - 10mm (paso 1.0) x 35mm
	PRECIO \$ 5.750		PRECIO \$ 3.650		PRECIO \$ 3.650		PRECIO \$ 3.450
Código 14-MA-22 30-146 / 30-232	Descripción Ojo y Gancho Daewoo - Ø 10mm	Código 14-MA-23 30-071 / 30-247	Descripción Hembra sin Ombbligo Chev. Monza - 10mm (paso 1.0) x 42.5mm	Código 14-MA-24	Descripción Hembra Hexagonal con Ombbligo Chev. Luv 2300 - 10mm (paso 1.0) x 35.5mm	Código 14-MA-25 30-223	Descripción Hembra con Ombbligo Mazda B1600 - 10mm (paso 1.25) x 39mm

	
PRECIO	\$ 2.900
Código	Descripción
14-MA-26	Macho Mazda - 10mm (paso 1.25) x 41mm

	
PRECIO	\$ 5.400
Código	Descripción
14-MA-27 30-032 / 30-047 / 30-285	Pin Ojo Mazda - Ø10mm

	
PRECIO	\$ 3.650
Código	Descripción
14-MA-28	Hembra Hexagonal con Ombligo Fresado Mazda Freno - 10mm (paso 1.0) x 35.5mm

	
PRECIO	\$ 3.850
Código	Descripción
14-MA-29	Huevo Pasante Doble Grafado Mazda x 50mm

	
PRECIO	\$ 3.450
Código	Descripción
14-MA-30	Huevo Pasante Hexagonal Fresada Mazda x 32mm

	
PRECIO	\$ 3.450
Código	Descripción
14-MA-31	Hembra con Ombligo Mazda 626 10mm (paso 1.0) x 38,5mm

	
PRECIO	\$ 3.650
Código	Descripción
14-MA-32	Hembra Hexagonal Fresada con Ombligo Mazda 121 - 10mm (paso 1.0) x 41mm

	
PRECIO	\$ 3.450
Código	Descripción
14-MA-33	Huevo Pasante Mazda Matsuri x 32mm

	
PRECIO	\$ 7.500
Código	Descripción
14-MA-34 30-234	Panela Daewoo Cielo Ø10mm

	
PRECIO	\$ 3.450
Código	Descripción
14-MA-35	Hembra con Ombligo Chevrolet NPR 10mm (paso 1.0) x 40mm

	
PRECIO	\$ 3.650
Código	Descripción
14-MA-36 30-363	Macho Ford Festiva 10mm (paso 1.0) x 49.5mm

	
PRECIO	\$ 3.650
Código	Descripción
14-MA-37 30-322	Macho Nissan MT3000 10mm (paso 1.0)

	
PRECIO	\$ 2.900
Código	Descripción
14-MA-38	Macho Universal 7/16" 20 NF x 41mm

	
PRECIO	\$ 2.900
Código	Descripción
14-MA-39 30-321	Macho corto 10mm (paso 1.0) x 39mm

	
PRECIO	\$ 3.050
Código	Descripción
14-MA-40	Macho Largo 10mm (paso 1.0) x 48.5mm

	
PRECIO	\$ 3.450
Código	Descripción
14-MA-41 30-009	Macho Corto 3/8" 24 NF x 39mm

	
PRECIO	\$ 3.050
Código	Descripción
14-MA-42	Macho Largo 3/8" 24 NF x 48.5mm

	
PRECIO	\$ 5.600
Código	Descripción
14-MA-43	Macho Hexagonal Ford 100/250 3/8" 24 NF x 71.7mm

	
PRECIO	\$ 3.650
Código	Descripción
14-MA-44	Hembra con Ombligo Hexagonal Ford 100/250 3/8" 24 NF x 41mm

	
PRECIO	\$ 6.150
Código	Descripción
14-MA-45 30-036	Ojo Pasador Nissan - Ø10mm

	
PRECIO	\$ 4.800
Código	Descripción
14-MA-46 30-137 / 30-263	Ojo Fresado Lada - Ø10mm

	
PRECIO	\$ 7.300
Código	Descripción
14-MA-47 30-265	Hembra Nissan sin Ombligo - 10mm (paso 1.0)

	
PRECIO	\$ 8.100
Código	Descripción
14-MA-48 30-266	Racord Ojo Nissan MT 3000 - Ø 10mm

	
PRECIO	\$ 3.450
Código	Descripción
14-MA-49	Hembra Hexagonal sin Ombligo Engrasadora - 1/8" NPT

PRECIO		\$ 2.900
		
Código	Descripción	
14-MA-50 30-021	Macho Engrasadora - 1/8" NPT	

PRECIO		\$ 3.450
		
Código	Descripción	
14-MA-51	Hembra sin Ombligo Pin 13mm Nissan - 10mm (paso 1.0)	

PRECIO		\$ 3.650
		
Código	Descripción	
14-MA-52	Hembra con Ombligo Ford - 7/16" 24 NF	

PRECIO		\$ 3.050
		
Código	Descripción	
14-MA-53 30-031	Chevrolet NPR - 10mm (paso 1.0)	

PRECIO		\$ 3.450
		
Código	Descripción	
14-MA-54	Macho Largo con Ombligo Hexagonal - 7/16" 20 NF	

PRECIO		\$ 3.250
		
Código	Descripción	
14-MA-55 30-387	Hembra sin Ombligo Alpine - 10mm (paso 1.0)	

PRECIO		\$ 3.650
		
Código	Descripción	
14-MA-56 14-MA-62 / 30-048	Hembra con Ombligo Chevrolet Luv Embrague - 12mm (paso 1.0)	

PRECIO		\$ 3.250
		
Código	Descripción	
14-MA-57	Macho Chevrolet NPR Embrague - 12mm (paso 1.5)	

PRECIO		\$ 3.850
		
Código	Descripción	
14-MA-58 30-023	Macho 5/8" 18 NF Hembra 3/8" 24 NF con Ombligo Nissan	

PRECIO		\$ 3.850
		
Código	Descripción	
14-MA-59 30-066	Embrague Macho - 16mm (paso 1.5) - Hembra 10mm Toyota (paso 1.0) Con Ombligo Kia	

PRECIO		\$ 3.850
		
Código	Descripción	
14-MA-60 30-016	Macho 5/8" 18 NF - Hembra 7/16" 24 NF con Ombligo	

PRECIO		\$ 2.900
		
Código	Descripción	
14-MA-61	Macho con Ombligo - 10mm (paso 1.0)	

PRECIO		\$ 3.850
		
Código	Descripción	
14-MA-63 30-169 / 30-197	Hembra Hexagonal con Ombligo Toyota - 10mm (paso 1.0)	

PRECIO		\$ 4.050
		
Código	Descripción	
14-MA-64	Hembra Hexagonal Fresada 2 Caras con Ombligo Toyota - 10mm (paso 1.0)	

PRECIO		\$ 4.800
		
Código	Descripción	
14-MA-65	Ojo y Gancho Corto Varios - Ø 10mm	

PRECIO		\$ 3.850
		
Código	Descripción	
14-MA-66 30-006	Macho Con Ombligo Willlys - 3/8" 24 NF	

PRECIO		\$ 4.050
		
Código	Descripción	
14-MA-67	Hembra Fresada con Ombligo Ford Hexagonal - 3/8" 24 NF	

PRECIO		\$ 4.450
		
Código	Descripción	
14-MA-68 30-313	Hembra sin ombligo Atos - 10mm (paso 1.0)	

PRECIO		\$ 3.250
		
Código	Descripción	
14-MA-69 30-170	Macho Lada Niva - 12mm (paso 1.25)	

PRECIO		\$ 3.650
		
Código	Descripción	
14-MA-70	Hembra Hexagonal sin Ombligo - 12mm (paso 1.25)	

PRECIO		\$ 6.150
		
Código	Descripción	
14-MA-71 30-049 / 30-249	Pin Ojo Delantera Derecha Toyota Burbuja - Ø 10mm	

PRECIO		\$ 8.650
		
Código	Descripción	
14-MA-72 30-288	Panela Largo Chevrolet Corsa Delantero	

PRECIO		\$ 7.100
		
Código	Descripción	
14-MA-73 30-090	Racord Daewoo Racer M10 x 1	

PRECIO		\$ 6.150
		
Código	Descripción	
14-MA-74	Ojo Manguera 3/16" - Ø 10mm	

	
PRECIO	\$ 6.150
Código	Descripción
14-MA-75	Ojo Manguera 1/4 - Ø 80mm

	
PRECIO	\$ 6.150
Código	Descripción
14-MA-77	Manguera de 3/16" Ø 8mm

	
PRECIO	\$ 6.150
Código	Descripción
14-MA-78	Manguera de 1/4 Ø 8mm

	
PRECIO	\$ 5.850
Código	Descripción
14-MA-79	Racord Freno de Aire Universal

	
PRECIO	\$ 6.750
Código	Descripción
14-MA-80	Freno de Aire Universal

	
PRECIO	\$ 6.900
Código	Descripción
14-MA-81 30-370	Ford Festiva

	
PRECIO	\$ 3.250
Código	Descripción
14-MA-82 30-357	Hembra sin Ombligo Hyundai Atos - 10mm (paso 1.0)

	
PRECIO	\$ 6.750
Código	Descripción
14-MA-83	Racord Chevrolet Monza Cuadrado Ø10mm

	
PRECIO	\$ 13.850
Código	Descripción
14-MA-84 30-261	Racor Cuadrante Trooper

	
PRECIO	\$ 6.150
Código	Descripción
14-MA-85	Racord Ojo Ø14 mm

	
PRECIO	\$ 6.750
Código	Descripción
14-MA-86	Racord Ojo Ø 12mm

	
PRECIO	\$ 2.900
Código	Descripción
14-MA-87	Racord 1/8" NPT Para Manguera 3/16"

	
PRECIO	\$ 2.300
Código	Descripción
14-MA-88	Racord Manguera Para Soldar

	
PRECIO	\$ 3.000
Código	Descripción
14-MA-89	Racord Capsula Manguera (7/8X24)

	
PRECIO	\$ 6.750
Código	Descripción
14-MA-90	Racord Capsula Manguera (7/8X35)

	
PRECIO	\$ 9.250
Código	Descripción
14-MA-100 30-442	Ojo Derecho Hyundai Starex

	
PRECIO	\$ 9.250
Código	Descripción
14-MA-101 30-442	Ojo Izquierdo Hyundai Starex

	
PRECIO	\$ 1.950
Código	Descripción
14-MA-102	Acople Roscado Hexagonal - 10mm (paso 1.0)

	
PRECIO	\$ 10.000
Código	Descripción
14-MA-103 30-296	Racord Chevrolet Vitara Sideric 10mm paso 1.0

	
PRECIO	\$ 4.800
Código	Descripción
14-MA-104	Macho Hexagonal Ford F-250 / F-350 - 7/16" x 20

	
PRECIO	\$ 9.600
Código	Descripción
14-MA-105 30-279	Racord Derecho Nissan Pick up Ø10mm

	
PRECIO	\$ 5.950
Código	Descripción
14-MA-106	Manguera Para Moto 1/8" X 7.5mm Corto

	
PRECIO	\$ 4.250
Código	Descripción
14-MA-107 30-283	Freno Macho 16mm (paso 1.5) - Hembra 10mm (paso 1.0) sin Ombligo Iveco

	
PRECIO	\$ 8.250
Código	Descripción
14-MA-108	Panela Mini Blazer Derecha

	PRECIO \$ 8.250		PRECIO \$ 9.600		PRECIO \$ 6.150		PRECIO \$ 5.400
Código 14-MA-109	Descripción Panela Mini Blazer Izquierda	Código 14-MA-110 30-280	Descripción Racord Izquierdo Nissan Pick up Ø10mm	Código 14-MA-111 30-381	Descripción Ojo Curvo Manguera Freno Hino (Buseton)	Código 14-MA-112 30-273 / 30-428 / 30-441	Descripción Pasante Manguera Freno Hino (Buseton)
	PRECIO \$ 6.750		PRECIO \$ 10.600		PRECIO \$ 10.600		PRECIO \$ 7.500
Código 14-MA-115	Descripción Racord Ojo M. Nissan Pin Ø10mm	Código 14-MA-116 30-272	Descripción Racord M. Derecho Espigo Largo Kia Sportage Ø10mm (paso 1.0)	Código 14-MA-117 30-271	Descripción Racord M. Izquierda Espigo Largo Kia Sportage Ø10mm (paso 1.0)	Código 14-MA-118 30-268	Descripción Racord M. Kia (paso 1.0)
	PRECIO \$ 9.450		PRECIO \$ 9.450		PRECIO \$ 9.450		PRECIO \$ 9.450
Código 14-MA-119	Descripción Racord Panela Chevrolet C10 Derecha Ø10mm	Código 14-MA-120 30-260	Descripción Racord Panela Ford 350 91 Ø10mm	Código 14-MA-121	Descripción Chevrolet Cheyenne 3500 95-96	Código 14-MA-122	Descripción Chevrolet C 10 Blazer Cheyenne C 1500
	PRECIO \$ 13.850		PRECIO \$ 8.100		PRECIO \$ 3.450		PRECIO \$ 3.450
Código 14-MA-123 30-241	Descripción Ford 350 Freno Delantera	Código 14-MA-124 30-046	Descripción Manguera Dodge 100/300 70/74	Código 14-MA-127	Descripción Hueco Pasante 17mm Hexagonal Mazda	Código 14-MA-128	Descripción Manguera 3/16" Para Soldar
	PRECIO \$ 4.250		PRECIO \$ 11.900		PRECIO \$ 13.850		PRECIO \$ 4.250
Código 14-MA-129	Descripción 1/8" NPT Manguera 3/16" Hembra sin Omblijo Engrasadora	Código 14-MA-132	Descripción Panela Dodge 100/300 Recto	Código 14-MA-133 30-041	Descripción Panela Escalonada Chevrolet C30	Código 14-MA-134 30-319	Descripción Volkswagen-Mercedes Sprinter
	PRECIO \$ 6.150		PRECIO \$ 1.950		PRECIO \$ 4.100		PRECIO \$ 6.750
Código 14-MA-135	Descripción Manguera 1/8" X 7.5mm Doblado Nuevo Para Moto	Código 14-MA-138	Descripción Capsula Manguera Para Soldar Moto	Código 14-MA-139	Descripción Manguera 1/8" X 7.5mm 45 Grados Para Moto	Código 14-MA-140	Descripción Racord Ojo Nissan Navarra Ø10mm

		PRECIO	\$ 7.300
Código	Descripción		
14-MA-141 30-378	Racord Ojo Espigo Largo Nissan Frontier Ø10mm		

		PRECIO	\$ 3.450
Código	Descripción		
14-MA-152	Capsula Para Manguera de 3/16"		

		PRECIO	\$ 2.750
Código	Descripción		
14-MA-153	Arandela en Cobre Para Racord		

		PRECIO	\$ 5.600
Código	Descripción		
14-MA-154	Tornillo Pasante Para Ojo 10mm (Paso 1.0)		

		PRECIO	\$ 5.450
Código	Descripción		
14-MA-155	Racord Ojo Moto con Gancho		

		PRECIO	\$ 7.450
Código	Descripción		
14-MA-156	Ojo Gancho Curvo de Rosca		

		PRECIO	\$ 3.500
Código	Descripción		
14-MA-157	Racord Macho 12mm (paso 1.0)		

		PRECIO	\$ 6.650
Código	Descripción		
14-MA-158	Nissan Frontier 2WD Navara / Pick Up (D22) (98...) Derecha		

		PRECIO	\$ 6.650
Código	Descripción		
14-MA-159	Nissan Frontier 2WD Navara / Pick Up (D22) (98...) Izq.		

		PRECIO	\$ 3.150
Código	Descripción		
14-MA-160	Racord Macho con Omblijo 12mm (paso 1.0)		

		PRECIO	\$ 7.000
Código	Descripción		
14-MA-161	Racord Ojo Kia Picanto Ion		

		PRECIO	\$ 6.900
Código	Descripción		
14-MA-162	Lata Pasante Hyundai i25 II Serie		

		PRECIO	\$ 3.700
Código	Descripción		
14-MA-163 30-115 / 30-277 / 30-248	Hembra Fresado con Omblijo 10mm (paso 1.0) tipo original Toyota		

		PRECIO	\$ 8.100
Código	Descripción		
14-MA-167	Ojo Hyundai i35 Delantero		

		PRECIO	\$ 5.250
Código	Descripción		
A30-002	Racord Ojo Ø10 mm Nucleo Pin Nissan Cabstar		

		PRECIO	\$ 3.650
Código	Descripción		
A30-005	Hembra 3/8"x24h Con Omblijo Willys		

		PRECIO	\$ 4.100
Código	Descripción		
A30-007	Hembra 3/8"x24h Con Omblijo Ford 100		

		PRECIO	\$ 2.750
Código	Descripción		
A30-008	Macho Land Rover Largo Mod. 71-76 Macho 3/8"x24h		

		PRECIO	\$ 2.450
Código	Descripción		
A30-013	Hembra M10x1.0 - Sin Omblijo R-9 y R-18		

		PRECIO	\$ 2.800
Código	Descripción		
A30-015	Macho 4000 M11x1.25		

		PRECIO	\$ 2.550
Código	Descripción		
A30-018	Macho Nissan M10x1.0		

		PRECIO	\$ 2.950
Código	Descripción		
A30-019	Hembra M10x1.0 Con Omblijo Toyota Mod. 80		

		PRECIO	\$ 2.700
Código	Descripción		
A30-020	Hembra M9x1.0 Con Omblijo Clutch Toyota		

		PRECIO	\$ 3.950
Código	Descripción		
A30-022	Macho Largo Chevrolet M11x1.25		

PRECIO		\$ 2.950
		
Código	Descripción	
A30-023	Toyota 6063 - 6064 5/18x18h - 3/8x24h Con Omblogo	

PRECIO		\$ 4.800
		
Código	Descripción	
A30-024 30-424	Pin Gancho de Mazda	

PRECIO		\$ 5.800
		
Código	Descripción	
A30-027	Macho Largo Freno Isuzu M12x1.0	

PRECIO		\$ 3.050
		
Código	Descripción	
A30-028	Hembra M10x1.0 Con Omblogo Mazda Trasera 86-90	

PRECIO		\$ 2.250
		
Código	Descripción	
A30-030	Entrepaña Mazda 626 y Luv 1600	

PRECIO		\$ 3.850
		
Código	Descripción	
A30-037	Entrepaña Mitsubishi Lancer	

PRECIO		\$ 3.450
		
Código	Descripción	
A30-038	Hembra Hexagonal M10x1.0 Con Omblogo Nissan Urban Trasera	

PRECIO		\$ 2.400
		
Código	Descripción	
A30-039	Macho M10x1.0 Nissan Urban Trasera	

PRECIO		\$ 3.050
		
Código	Descripción	
A30-042	Macho P-30 C-30 5/18x18h - Hembra 3/8x24h Con Omblogo	

PRECIO		\$ 7.050
		
Código	Descripción	
A30-044	Racord Ojo Ø11 mm Panela C-10 C-30 77021 [RYL]	

PRECIO		\$ 2.950
		
Código	Descripción	
A30-045	Racord 5/18x18h - 3/8x24h Con Omblogo C-10 C-30 77021-L	

PRECIO		\$ 4.700
		
Código	Descripción	
A30-048	Hembra M12x1 Clutch Luv 2300	

PRECIO		\$ 5.150
		
Código	Descripción	
A30-052	Hembra Hexagonal M10x1 Luv 2300	

PRECIO		\$ 2.650
		
Código	Descripción	
A30-053	Hembra M11x1.0 Con Omblogo Dodge Dart	

PRECIO		\$ 4.450
		
Código	Descripción	
A30-054	Macho M12x1.0 Ford Fairmont y Zephir	

PRECIO		\$ 2.350
		
Código	Descripción	
A30-055	Macho M10x1.25 Fiat /147 Delantera	

PRECIO		\$ 3.300
		
Código	Descripción	
A30-056	Racord Ojo Ø10 mm Panela Taxi Lada 1600	

PRECIO		\$ 3.200
		
Código	Descripción	
A30-057	Hembra M10x1.25 - Sin Omblogo Fiat Trasera	

PRECIO		\$ 3.150
		
Código	Descripción	
A30-058	Hembra M10x1.0 - Sin Omblogo Chevette Delantera y Trasera	

PRECIO		\$ 2.350
		
Código	Descripción	
A30-059	Hembra M10x1.0 Con Omblogo Nissan Mod 80 / 84	

PRECIO		\$ 2.350
		
Código	Descripción	
A30-060	Macho M10x1.25 Mazda B 1600 Delantera	

PRECIO		\$ 3.350
		
Código	Descripción	
A30-061	Macho M10x1.0 Volkswagen	

PRECIO		\$ 4.250
		
Código	Descripción	
A30-062	Macho 7/16x20h Clutch Toyota	

PRECIO		\$ 3.000
		
Código	Descripción	
A30-063	Macho M11x1.25 Clutch Land Rover	

PRECIO		\$ 5.450
		
Código	Descripción	
A30-070	Hembra M10x1.0 Con Ombligo Kia Carnival	

PRECIO		\$ 5.250
		
Código	Descripción	
A30-072	Hembra M10x1 Npr Delantera	

PRECIO		\$ 3.600
		
Código	Descripción	
A30-073	Hembra M10x1.0 Con Ombligo NPR Trasera	

PRECIO		\$ 6.050
		
Código	Descripción	
A30-074	Entrepaña Triangular Honda Civic	

PRECIO		\$ 350
		
Código	Descripción	
A30-100 04-EM-01	Pin Banda	

PRECIO		\$ 4.400
		
Código	Descripción	
A30-101	Racord Ojo Ø10 mm Gancho Mazda B-2200 Delantera	

PRECIO		\$ 4.200
		
Código	Descripción	
A30-109	Hembra M10x1.25 - Sin Ombligo Volga Delantera	

PRECIO		\$ 3.450
		
Código	Descripción	
A30-110	Hembra M10x1.0 - Sin Ombligo Volkswagen	

PRECIO		\$ 4.150
		
Código	Descripción	
A30-112	Hembra 3/8"x24h Con Ombligo 3/16 4975	

PRECIO		\$ 3.000
		
Código	Descripción	
A30-113	Hembra 7/16x24h Con Ombligo 4999 -7/16	

PRECIO		\$ 5.900
		
Código	Descripción	
A30-117	Racord Ojo Ø10 mm Gancho Toyota Corolla	

PRECIO		\$ 9.250
		
Código	Descripción	
A30-121	Nucleo de Bola de 3/4"	

PRECIO		\$ 6.050
		
Código	Descripción	
A30-123	Entrepaña Platina Honda Civic	

PRECIO		\$ 5.300
		
Código	Descripción	
A30-124	Racord Ojo Ø10 mm Panela Impala Nova	

PRECIO		\$ 4.500
		
Código	Descripción	
A30-125	Racord Ojo Ø11 mm Panela Monza Todos	

PRECIO		\$ 2.500
		
Código	Descripción	
A30-132	Platina 77-760 Derecha	

PRECIO		\$ 2.500
		
Código	Descripción	
A30-133	Platina 77-761 Izquierda	

PRECIO		\$ 6.900
		
Código	Descripción	
A30-134	Racord Ojo Ø10 mm Panela 77-760,761 Chevrolet Blazer	

PRECIO		\$ 6.750
		
Código	Descripción	
A30-135	Macho NPT de 3/8 Para Manguera Freno Der	

PRECIO		\$ 7.200
		
Código	Descripción	
A30-140	Racord Ojo Ø10 mm Panela C-30 Mod-85 Chevrolet	

PRECIO		\$ 3.200
		
Código	Descripción	
A30-142	Hembra 3/8"x24h Con Ombligo 77-235 Ford 350	

PRECIO		\$ 2.900
		
Código	Descripción	
A30-144	Macho M10x1.0 Toyota Delantero M-80	

PRECIO		\$ 3.950
		
Código	Descripción	
A30-149	Macho M11 x 1.25 Ford 100	

PRECIO		\$ 6.000
		
Código	Descripción	
A30-151	B-21 De 3/16"	

PRECIO		\$ 3.000
		
Código	Descripción	
A30-152	Machete 3/8" x 24H	

PRECIO		\$ 2.500
		
Código	Descripción	
A30-153	Hembra M11x1.0 Con Ombigo 65-60 Chevrolet	

PRECIO		\$ 2.450
		
Código	Descripción	
A30-167	Nucleo de Bola	

PRECIO		\$ 3.850
		
Código	Descripción	
A30-171	Racord 5/8x18h - 7/16x24h Con Ombigo AS-45	

PRECIO		\$ 3.850
		
Código	Descripción	
A30-173	Copa 5/18 x 18H - Int 3/8 x 24H Con Hombigo Cherokee	

PRECIO		\$ 3.900
		
Código	Descripción	
A30-175	Machete M12x1.25 Cultch Polsky Lada	

PRECIO		\$ 3.650
		
Código	Descripción	
A30-176	Hembra M12x1.25 - Sin Ombigo Clutch Fiat y Lada	

PRECIO		\$ 4.500
		
Código	Descripción	
A30-181	Copa de 1/8 Clutch Isuzu	

PRECIO		\$ 8.000
		
Código	Descripción	
A30-190	Racord Ojo Ø9.5 mm Willys	

PRECIO		\$ 7.800
		
Código	Descripción	
A30-191	Racord Ojo Ø9.5 mm Panela 80977 Ford 150 [L]	

PRECIO		\$ 4.850
		
Código	Descripción	
A30-193	Machete 7/16x24h Ford Galaxia Largo	

PRECIO		\$ 10.450
		
Código	Descripción	
A30-194	Terminal Gancho Largo 88994 Der.	

PRECIO		\$ 10.450
		
Código	Descripción	
A30-195	Terminal Gancho Largo 88994 Lqz.	

PRECIO		\$ 7.150
		
Código	Descripción	
A30-196	Panela Ojo Ø12 mm Ford Maveric	

PRECIO		\$ 2.400
		
Código	Descripción	
A30-198	Hembra 3/8"x24h Con Ombigo Ford Lariat	

PRECIO		\$ 13.850
		
Código	Descripción	
A30-199	Racord Ojo Ø9.5 mm Panela 97-840	

PRECIO		\$ 11.900
		
Código	Descripción	
A30-200	Racord Ojo Ø10 mm Panela Ford Lariat Otz-2078-B[L]	

PRECIO		\$ 11.900
		
Código	Descripción	
A30-201	Racord Ojo Ø10 mm Panela Ford Lariat Otz-2078[R]	

PRECIO		\$ 2.500
		
Código	Descripción	
A30-206 07-FM-35	Platina Hyundai Accent Derecha	

PRECIO		\$ 2.500
		
Código	Descripción	
A30-208 07-FM-34	Platina Hyundai Accent Izquierda	

PRECIO		\$ 4.300
		
Código	Descripción	
A30-210	Panela Ojo Ø10 mm Blazer Delantera L	

PRECIO		\$ 3.100
		
Código	Descripción	
A30-211	Machete Largo M10x1.0 Ford Sierra Delantera	

PRECIO		\$ 3.850
		
Código	Descripción	
A30-217	Casquete Para Mang. 3/8"	

PRECIO		\$ 2.700
		
Código	Descripción	
A30-226	Copa Freno Delantera Ford Ltd Venezuela	

PRECIO		\$ 7.450
		
Código	Descripción	
A30-233	Panela Ford Trasera 97-98	

PRECIO		\$ 3.200
		
Código	Descripción	
A30-236	Hembra 3/8"x24h Con Omblijo Mini Blazer	

PRECIO		\$ 3.800
		
Código	Descripción	
A30-244	Platina Mini Blazer Izq.	

PRECIO		\$ 3.800
		
Código	Descripción	
A30-245	Platina Mini Blazer Der.	

PRECIO		\$ 5.250
		
Código	Descripción	
A30-246	Hembra M10x1.0 Con Omblijo Honda	

PRECIO		\$ 3.700
		
Código	Descripción	
A30-256	Macho 7/16 x 24H Largo Ford	

PRECIO		\$ 3.800
		
Código	Descripción	
A30-262	Hembra 3/8"x24h Con Omblijo Daihatsu Mod 83	

PRECIO		\$ 4.250
		
Código	Descripción	
A30-264	Racord Pasante Daihatsu Mod 83	

PRECIO		\$ 600
		
Código	Descripción	
A30-267	Soporte Manguera Ford 350	

PRECIO		\$ 700
		
Código	Descripción	
A30-269 03-AC-06	Caucho Para Mangueras Varias	

PRECIO		\$ 3.000
		
Código	Descripción	
A30-275	Entrepaña Soporte Hyundai Elentra del (R)	

PRECIO		\$ 3.000
		
Código	Descripción	
A30-276	Entrepaña Hyundai Elentra Del (L) Soporte	

PRECIO		\$ 4.550
		
Código	Descripción	
A30-284	Hembra M10x1.0 Con Omblijo Toyota Hilux 4x4 Trasera	

PRECIO		\$ 6.500
		
Código	Descripción	
A30-286	Racord Ojo Ø10 mm Gancho Toyota Yaris Todos	

PRECIO		\$ 7.350
		
Código	Descripción	
A30-295	Racord Ojo Ø10 mm Panela Nissan Pathfinder	

PRECIO		\$ 8.350
		
Código	Descripción	
A30-297	Panela 3/8x24h Derecha Ford Ranger	

PRECIO		\$ 7.200
		
Código	Descripción	
A30-298	Racord Ojo Ø9.5 mm Panela Ford Ranger General	

PRECIO		\$ 8.300
		
Código	Descripción	
A30-299	Panela 3/8x24h Con Omblijo Izquierda Ford Ranger	

PRECIO		\$ 1.400
		
Código	Descripción	
A30-301	Caucho Volkswagen	

PRECIO		\$ 3.000
		
Código	Descripción	
A30-305	Macho M10x1.25 Fiat Premium y Otros	

PRECIO		\$ 700
		
Código	Descripción	
A30-307	Platina Honda Civic (L)	

PRECIO		\$ 1.200
		
Código	Descripción	
A30-308	Caucho Honda Civic	

PRECIO		\$ 3.450
		
Código	Descripción	
A30-311	Entrepaña Mazda B-2600	

PRECIO		\$ 3.650
		
Código	Descripción	
A30-312	Hembra M10x1.0 Con Omblijo Mazda B-2600	

PRECIO		\$ 5.400
		
Código	Descripción	
A30-314	Racord Ojo Ø10 mm Gancho Toyota Rav	

PRECIO		\$ 5.050
		
Código	Descripción	
A30-317	Racord Ojo Toyota Coster	

PRECIO		\$ 5.250
		
Código	Descripción	
A30-318	Hembra M10x1.0 - Sin Ombligo Buseta Mercedes Benz Sprinter	

PRECIO		\$ 3.650
		
Código	Descripción	
A30-320	Hembra M10x1.0 - Sin Ombligo Freno Fiat 131	

PRECIO		\$ 700
		
Código	Descripción	
A30-325	Platina Honda Civic (R)	

PRECIO		\$ 4.800
		
Código	Descripción	
A30-327	Entrepáño Chevrolet D-MAX 4x2 (R)	

PRECIO		\$ 3.300
		
Código	Descripción	
A30-328	Entrepáño Chevrolet D-MAX 4x2 (L)	

PRECIO		\$ 5.600
		
Código	Descripción	
A30-329	Racord Ojo Ø10 mm Gancho Chevrolet D-MAX 4x2 (R)	

PRECIO		\$ 5.400
		
Código	Descripción	
A30-330	Racord Ojo Ø10 mm Gancho Chevrolet D-MAX 4x2 (L)	

PRECIO		\$ 1.000
		
Código	Descripción	
A30-332	Caucho Renault Megane	

PRECIO		\$ 3.350
		
Código	Descripción	
A30-335	Hembra M10x1.0 Con Ombligo Chevrolet D-MAX 4x4	

PRECIO		\$ 4.850
		
Código	Descripción	
A30-336	Entrepáño Chevrolet D-MAX 4x4 (R)	

PRECIO		\$ 4.850
		
Código	Descripción	
A30-337	Entrepáño Chevrolet D-MAX 4x4 (L)	

PRECIO		\$ 8.150
		
Código	Descripción	
A30-338	Racord Ojo Ø10 mm Gancho Chevrolet D-MAX 4x4 (R)	

PRECIO		\$ 8.150
		
Código	Descripción	
A30-339	Racord Ojo Ø10 mm Gancho Chevrolet D-MAX 4x4 (L)	

PRECIO		\$ 3.050
		
Código	Descripción	
A30-340	Tuerca Manguera NPR	

PRECIO		\$ 3.450
		
Código	Descripción	
A30-344	Hembra M10x1.0 - Sin Ombligo Kia Sephia	

PRECIO		\$ 3.650
		
Código	Descripción	
A30-347	Hembra M10x1.0 Con Ombligo Daihatsu F-20	

PRECIO		\$ 4.450
		
Código	Descripción	
A30-353	Macho M10 x 1.0 Peugeot 405	

PRECIO		\$ 6.200
		
Código	Descripción	
A30-354	Racord Ojo Ø10 mm Gancho Moto Keway	

PRECIO		\$ 3.550
		
Código	Descripción	
A30-355	Macho 3/8"x28h Clutch Hino	

PRECIO		\$ 6.950
		
Código	Descripción	
A30-356	Macho 3/8x24h Hino	

PRECIO		\$ 3.450
		
Código	Descripción	
A30-359	Entrepáño Kia Rio	

PRECIO		\$ 2.700
		
Código	Descripción	
A30-372	Entrepáño Chevrolet Optra	

PRECIO		\$ 2.950
		
Código	Descripción	
A30-373	Macho M10x1.0 Hino	

PRECIO		\$ 6.150
		
Código	Descripción	
A30-376	Racord Ojo Ø10 mm Gancho Pin Nissan Frontier del 4x2 R	

PRECIO		\$ 6.500
		
Código	Descripción	
A30-377	Racord Ojo Ø10 mm Gancho Pin Nissan Frontier 4x2 L	

PRECIO		\$ 7.150
		
Código	Descripción	
A30-379	Hembra M10x1.0 Con Ombligo Nissan Frontier Izquierda	

PRECIO		\$ 7.150
		
Código	Descripción	
A30-380	Hembra M10x1.0 Con Ombligo Nissan Frontier Derecha	

PRECIO		\$ 6.150
		
Código	Descripción	
A30-381	Ojo Ø10 mm Gancho Curvo Hino Freno Delantera	

PRECIO		\$ 4.200
		
Código	Descripción	
A30-382	Hembra M12x1.0 Con Ombligo Clutch Chevrolet NKR Mod 2009	

PRECIO		\$ 3.100
		
Código	Descripción	
A30-388	Macho Largo 3/8" x 24H Trasero Montero Mitsubishi	

PRECIO		\$ 6.050
		
Código	Descripción	
A30-398	Racord Ojo Ø10 mm Gancho Toyota Hiace Izquierdo	

PRECIO		\$ 6.050
		
Código	Descripción	
A30-399	Racord Ojo Ø10 mm Gancho Toyota Hiace Derecho	

PRECIO		\$ 3.100
		
Código	Descripción	
A30-403	Entrepáño Soporte Hyundai Starex (R)	

PRECIO		\$ 3.100
		
Código	Descripción	
A30-404	Entrepáño Soporte Hyundai Starex (L)	

PRECIO		\$ 2.850
		
Código	Descripción	
A30-412	Entrepáño Chevrolet N300 - Renault Kangoo	

PRECIO		\$ 2.200
		
Código	Descripción	
A30-413	Macho M10 x 1.0 Hyundai Camion Hd-72	

PRECIO		\$ 2.600
		
Código	Descripción	
A30-415	Hembra M10 x 1.0 Con Ombligo Copa Hyundai Camion Hd-72	

PRECIO		\$ 2.450
		
Código	Descripción	
A30-416	Entrepáño Mazda 3	

PRECIO		\$ 4.250
		
Código	Descripción	
A30-421	Macho M10 x 1.0 Hino Fd	

PRECIO		\$ 5.450
		
Código	Descripción	
A30-444	Hembra Sin Ombligo M10x1.0 Honda CR-V	



MATERIA PRIMA





Manguera Freno Hidraulico

Manguera Hidráulica SAE J1401

CODIGO	DESCRIPCIÓN	DIMENSION	PRECIO
09-Mgr-06	Manguera Hidraulica 1/8	3.2 mm x 10.5 mm	\$ 8.600
09-Mgr-11	Manguera Hidraulica 3/16	4.8 mm x 12.5 mm	\$ 8.500



Manguera Freno Blindada 1/8

Manguera Hidráulica Blindada

CODIGO	DESCRIPCIÓN	DIMENSION	PRECIO
09-Mgr-07	Manguera Hidraulica Hidraulica 1/8	3.2 mm x 7.5 mm	\$ 14.000



Mang. Hidráulica Trenza Metálica

Manguera Hidráulica Trenza Metálica

CODIGO	DESCRIPCIÓN	DIMENSION	PRECIO
09-Mgr-08	Manguera Hidráulica 1/4	6.5 mm x 14.5 mm	\$ 8.500



Manguera Freno de Aire

Manguera Freno de Aire

CODIGO	DESCRIPCIÓN	DIMENSION	PRECIO
09-Mgr-09	Manguera Freno de Aire 3/8	10 mm x 19 mm	\$ 6.050
09-Mgr-10	Manguera Freno de Aire 1/2	13 mm x 22 mm	\$ 6.600



Manguera Esponjada

Manguera de Refuerzo Esponjada

CODIGO	DESCRIPCIÓN	DIMENSION	PRECIO
09-Mgr-12	25mm	17mm	\$ 3.800



Manguera para Alta Temperatura

Manguera de Refuerzo de Alta Temperatura

CODIGO	DESCRIPCIÓN	DIMENSION	PRECIO
09-Mgr-22	Manguera para alta temperatura con fibra de vidrio trenzada	-	\$ 18.000

MANGUERAS

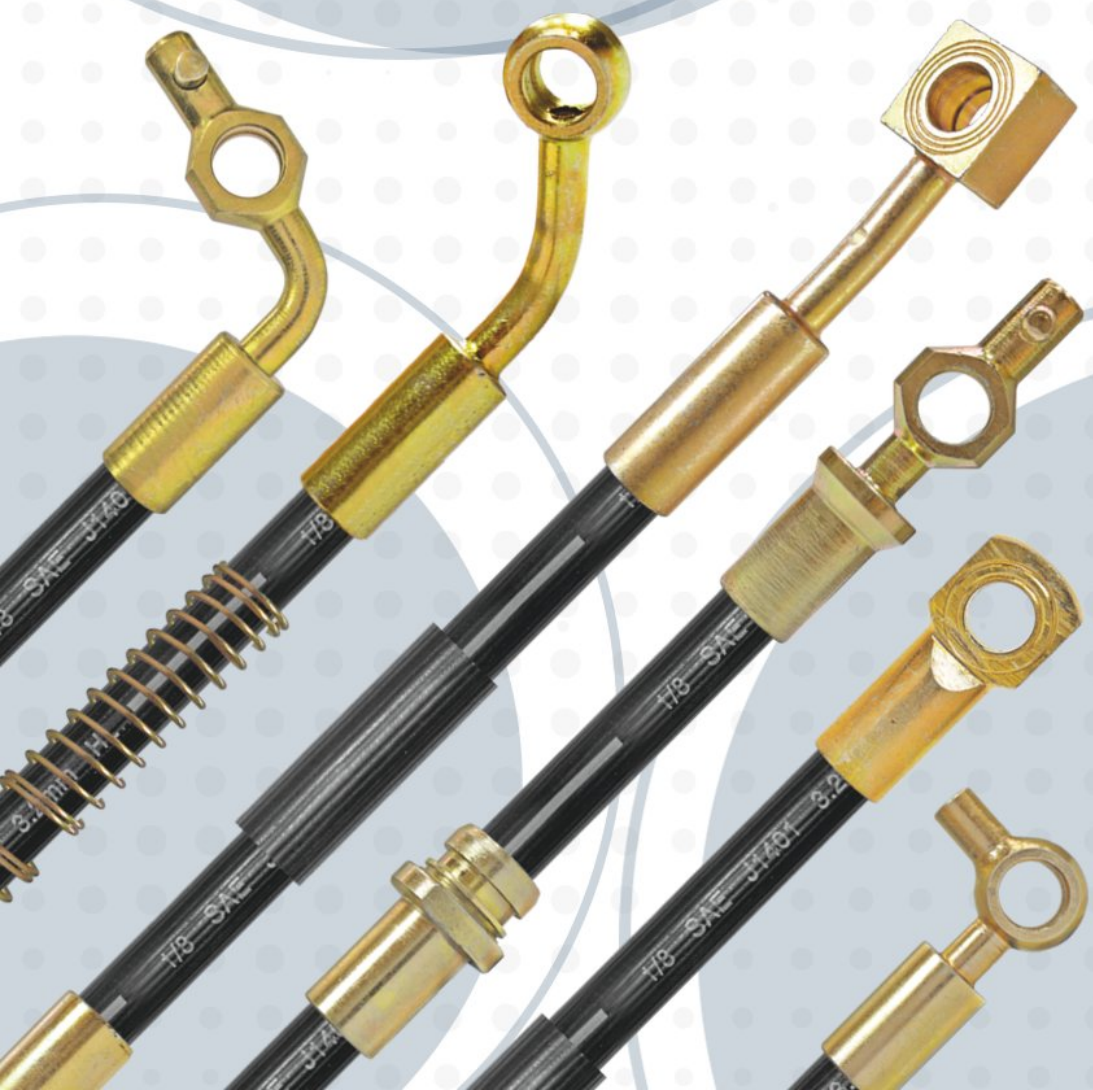



CHINOS

Codigo	45-33-01	
		
Chana Delantera		
Hembra M10x1		Long. 47cm
Hembra M10x1		

Codigo	37-M505	
		
Chana Trasera		
Hembra 10mm (paso 1.0) sin Ombligo		Long. 31cm
Hembra 10mm (paso 1.0) sin Ombligo		

Codigo	37-M506	
		
Chana Star Van Ojo X H Delantera		
Racord Ojo Largo Curvo Ø10mm		Long. 58cm
Hembra 10mm (Paso 1.0) x 34mm Con Ombligo		

Codigo	37-M507	
		
Chana Star Van HXM Trasera		
Macho 10mm (paso 1.0) x 40mm		Long. 46cm
Hembra Hexagonal 10mm (paso 1.0) x 35mm con Ombligo		

Codigo	37-M501	45-33-02
		
Chana Camioneta Hembra x Ojo Delantera		
Racord Ojo Largo Curvo Ø10mm		Long. 56,5cm
Hembra 10mm (paso 1.0) sin Ombligo		

Codigo	37-M502	
		
Chana Camioneta Hembra x Macho Delantera		
Macho 10mm (paso 1.0) x 40mm		Long. 44,3cm
Hembra Hexagonal 10mm (paso 1.0) x 35mm con Ombligo		

Codigo	45-31-02	
		
DFM Camioneta Delantera		
Macho M10x1		Long. 43.4 cm
Hembra M10x1		

Codigo	45-31-03	
		
DFM Camioneta Trasera		
Hembra M10x1		Long. 30.2 cm
Hembra M10x1		

Codigo	37-M508	
		
DFM (HxM) Trasera		
Macho 10mm (paso 1.0) x 40mm		Long. 44cm
Hembra 10mm (Paso 1.0) x 34mm Con Ombligo		

Codigo	37-M510	
		
DFS -C35 Delantera		
Racord Ojo Largo Curvo Ø10mm		Long. 55cm
Hembra 10mm (Paso 1.0) x 34mm Con Ombligo		

CHINOS

Codigo	37-M504	
		
Hafei Camioneta Hembra x Macho Delantera		
Macho 10mm (paso 1.0) x 40mm		Long. 44,4cm
Hembra 10mm (paso 1.0) x 34.5mm Con Omblico		

Codigo	37-M509	
		
Hafei Delantera		
Racord Ojo Largo Curvo Ø10mm		Long. 58cm
Hembra 10mm (Paso 1.0) x 34mm Con Omblico		

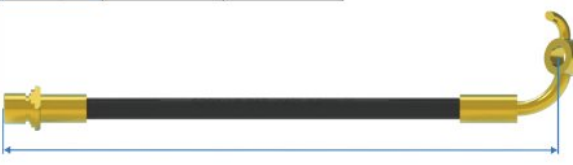
Codigo	45-41-01	
		
Jinbei H2 2013/2016 Joylong 2013/2016 (Der) Delantera		
Hembra Fresado 10mm (paso 1.0) con Omblico		Long. 37cm
Racord Ojo y Gancho Ø10mm		

Codigo	45-41-02	
		
Jinbei H2 2013/2016 Joylong 2013/2016 (Izq) Delantera		
Hembra Fresado 10mm (paso 1.0) con Omblico		Long. 36cm
Racord Ojo y Gancho Ø10mm		

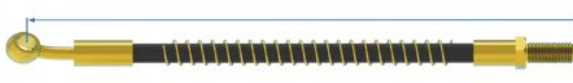
Codigo	45-31-01	
		
Mahindra Scorpio 2.5 2004-2018 (Izq-Der) Delantera		
Macho M10x1		Long. 41cm
Racord Ojo Ø10mm		

Codigo	37-M503	
		
Saic Wuling 2008 Hembra x Macho Delantera		
Macho 10mm (paso 1.0) x 40mm		Long. 40,5cm
Hembra Fresado Hexagonal 10mm (paso 1.0) x 35.5mm con Omblico		

CHEVROLET

Manguera Lubricación

Codigo	48-03-01	
		
Chevrolet Alternador Npr Isuzu Lubricación		
Racord Ojo Ø10mm		Long. 24cm
Racord Ojo Ø10mm		

		
Racord Ojo Ø10mm Racord Ojo Ø8.2mm		
Longitud	Descripcion	Codigo
21cm	Chevrolet Isuzu/Luv Diesel Ojo-Ojo Corta Lubricación	48-03-02
25cm	Chevrolet Isuzu/Luv Diesel Ojo-Ojo Larga Lubricación	48-03-03

Manguera Aire

Codigo	44-03-01	
		
Chevrolet C70-B60 / M X H Trasera Freno Aire		
Tuerca 7/8"		Long. 64cm
Macho 7/8"		

Codigo	44-03-07	
		
Chevrolet Nqr Freno Aire		
Hembra M20		Long. 43,5cm
Hembra M20		

CHEVROLET

Manguera Aire



Hembra M16x1.5 Hembra M16x1.5		
Longitud	Descripcion	Codigo
50cm	Chevrolet Npr Isuzu Mod 2000... Freno Aire	44-03-04
86,4cm	Chevrolet Npr x34" Trasera Freno Aire	44-03-05



Macho 7/8"x14h -Rca. Int. 1/4"x18H Macho 7/8"x14H -Rca. Int. 1/4"x18H		
Longitud	Descripcion	Codigo
60cm	Chevrolet Delantera Freno Aire	44-03-02
37cm	Chevrolet C70-B60 HCA Freno Aire	44-03-03
60cm	Chevrolet Npr Sitp Freno Aire	44-03-06

Manguera Embrague

Codigo	11-M578	39-03-06
--------	---------	----------

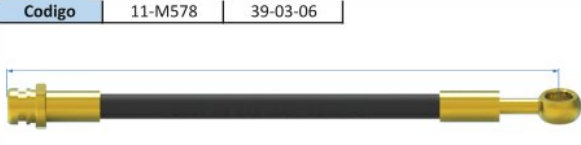

Chevrolet Aveo 1.6 Todos Embrague		
Hembra 10mm (paso 1.0) x 34.5mm Con Ombligo	Long.	27cm
Racord Ojo Largo Ø10mm		

Codigo	11-M501	39-03-01
--------	---------	----------

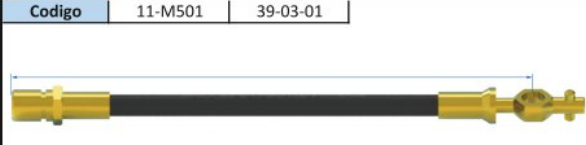

Chevrolet Luv 2300 Embrague		
Racord Ojo Pin Ø10mm	Long.	37cm
Hembra 12mm (paso 1.0) con Ombligo		

Codigo	11-M502	
--------	---------	--



Chevrolet Luv Embrague		
Racord Ojo y Gancho Ø10mm	Long.	39,5cm
Hembra Hexagonal 12mm (paso 1.0) con Ombligo		

Codigo	11-M503	
--------	---------	--

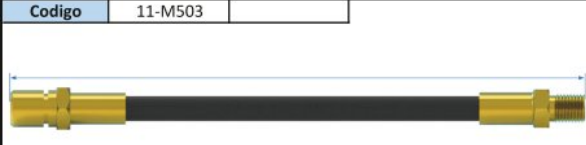

Chevrolet Npr ...95 14" Embrague		
Macho 12mm (paso 1.5)	Long.	36,5cm
Hembra Hexagonal 12mm (paso 1.0) con Ombligo		

Codigo	39-03-04	
--------	----------	--



Chevrolet Nkr Bomba Auxiliar Embrague		
Macho M12x1.5	Long.	40cm
Hembra Rca Int. M12x1		

Codigo	39-03-05	
--------	----------	--

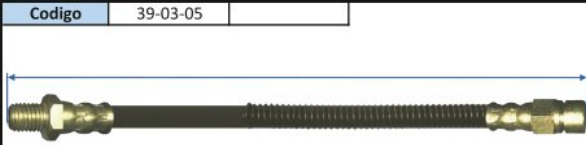

Chevrolet Nkr Mod. 2009... Embrague		
Macho M12x1.5	Long.	47cm
Hembra Rca Int. M12x1		

Codigo	39-03-03	
--------	----------	--



Chevrolet Trooper Bomba Auxiliar Embrague		
Racord Ojo Ø10mm	Long.	32cm
Hembra Rca Int. M12x1		



Hembra Embrague 12mm (paso 1.0) con Ombligo Macho 12mm (paso 1.5)		
Longitud	Descripcion	Codigo
45,5cm	Chevrolet Npr 96... 17" Embrague	11-M504
37cm	Chevrolet Npr Bomba Auxiliar Embrague	11-M505 / 39-03-02

CHEVROLET

Manguera Freno



Hembra 10mm (Paso 1.0) x 34mm Con Ombliigo
Racord Ojo Corto Ø10mm

Longitud	Descripcion	Codigo
46cm	Chevrolet Alto Delantera	11-M506
46cm	Chevrolet Sprint Delantera	11-M559 / 45-03-26



Hembra 10mm (Paso 1.0) x 34mm Con Ombliigo
Racord Ojo Corto Ø10mm

Longitud	Descripcion	Codigo
31cm	Chevrolet Alto Trasera	11-M507 / 45-03-44
24cm	Chevrolet Esteem Trasera	11-M533 / 45-03-43
25,5cm	Chevrolet Sprint Trasera	11-M560 / 45-03-27
25,5cm	Chevrolet Super Carry Trasera	11-M562
25cm	Chevrolet Swift 1.0 Trasera	11-M563 / 45-03-29
26cm	Chevrolet Spark 7:24 Trasera	11-M577 / 45-03-62

Codigo 45-03-82



Chevrolet Aveo Trasera

Hembra M10x1	Long.	23cm
Hembra M10x1		

Codigo 45-03-83



Chevrolet Aveo Gti Delantera

Racord Ojo Ø10mm	Long.	37,2cm
Hembra M10x1		

Codigo 11-M588



Chevrolet Aveo-Spark Gt Delantera

Racord Ojo Largo Ø10mm	Long.	33,5cm
Hembra 10mm (Paso 1.0) x 34mm Con Ombliigo		

Codigo 45-03-56



Chevrolet Blazer M 73-84 Derecha Delantera

Hembra Rca Ext. 3/8x24H	Long.	56cm
Racord Panela Cuadrada Ojo Ø10mm		



Hembra 10mm (paso 1.0) x 34.5mm Con Ombliigo
Racord Ojo Largo Ø10mm

Longitud	Descripcion	Codigo
36cm	Chevrolet Aveo 1.6 Todos (R/L) Trasera	11-M583
36cm	Chevrolet Aveo 1.6 Todos (R/L) Delantera	11-M584 / 45-03-67

Codigo 45-03-57



Chevrolet Blazer M 73-84 Izquierda Delantera

Hembra 3/8"x24h Con Ombliigo	Long.	56cm
Racord Panela Ojo Ø10 mm		

Codigo 11-M589 45-03-84/85



Chevrolet Captiva Delantera Der/Izq Sin soporte Delantera

Racord Ojo Largo Ø10mm	Long.	47,8cm
Hembra 10mm (Paso 1.0) x 34mm Con Ombliigo		

Codigo 11-M590

Chevrolet Captiva Trasera

	Long.	
--	-------	--

CHEVROLET

Manguera Freno



Macho Rca.Ext. 5/8"x18H - Rca.Int. 3/8"x24H
Racord Panela Cuadrada Ojo Ø12mm

Longitud	Descripcion	Codigo
60cm	Chevrolet C10 Izquierda Delantera	45-03-15
60cm	Chevrolet C10 Derecha Delantera	45-03-16



Macho Rca.Ext. 5/8"x18H - Rca.Int. 3/8"x24H
Racord Panela Cuadrada Ojo Ø12mm

Longitud	Descripcion	Codigo
59cm	Chevrolet C30-P30 Izquierda Delantera	45-03-17
59cm	Chevrolet C30-P30 Derecha Delantera	45-03-18

Codigo 45-03-19



Chevrolet C10-C30 Trasera

Longitud	Descripcion	Codigo
38cm	Hembra Rca Int. 7/16"x24H Panela Cuadrada Ojo Ø10mm	

Codigo 45-03-37



Chevrolet C30-P30 Mod Nuevo 85... Delantera

Longitud	Descripcion	Codigo
58cm	Hembra Rca Ext. 3/8x24H Panela Cuadrada Ojo Ø10mm	



Racord Panela C 10 Blazer Cheyenne C 1500
Hembra Fresada Hexagonal 3/8" 24 NF con Ombligo

Longitud	Descripcion	Codigo
64,5cm	Chevrolet C10/Blazer/Cheyenne C1500 Der. Delantera	11-M514 / 45-03-01
64,5cm	Chevrolet C10 Blazer Cheyenne C1500 Izq. Delantera	11-M515 / 45-03-02



Hembra 10mm (paso 1.0) x 45.5mm sin Ombligo
Hembra 10mm (paso 1.0) x 45.5mm sin Ombligo

Longitud	Descripcion	Codigo
39cm	Chevrolet Chevette 88... Delantera	11-M524 / 45-03-11
28cm	Chevrolet Chevette 88... Trasera	11-M525 / 45-03-12



Hembra 10mm (paso 1.0) x 44.5mm Con Ombligo
Hembra 10mm (paso 1.0) x 44.5mm Con Ombligo

Longitud	Descripcion	Codigo
39cm	Chevrolet Chevette 83 - 88 Delantera	11-M526 / 45-03-13
28cm	Chevrolet Chevette 83 - 88 Trasera	11-M527 / 45-03-14 11-M525



Racord Panela Cheyenne 3500 95-96
Hembra Fresada Hexagonal 3/8" 24 NF con Ombligo

Longitud	Descripcion	Codigo
57,5cm	Chevrolet Cheyenne 3500 95/96 Derecha Delantera	11-M528
57,5cm	Chevrolet Cheyenne 3500 95/96 Izquierda Delantera	11-M529

Codigo 11-M530 45-03-47



Chevrolet Corsa Delantera

Longitud	Descripcion	Codigo
37,5cm	Hembra 10mm (paso 1.0) x 42.5mm sin Ombligo Racord Panela Largo Delantero Corsa	



Hembra 10mm (paso 1.0) x 42.5mm sin Ombligo
Hembra 10mm (paso 1.0) x 42.5mm sin Ombligo

Longitud	Descripcion	Codigo
24cm	Chevrolet Corsa Trasera	11-M531 / 45-03-48
22cm	Chevrolet Monza Trasera	11-M548

CHEVROLET

Manguera Freno

Codigo	45-03-63	
		
Chevrolet D-Max 4x2 Derecha Delantera		
Hembra Rca Int. M10x1		Long. 46cm
Racord Ojo Ø10mm		

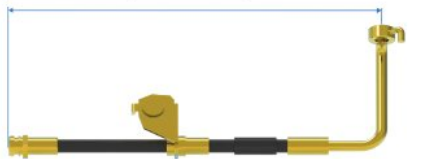
Codigo	45-03-64	
		
Chevrolet D-Max 4x2 Izquierda Delantera		
Hembra Rca Int. M10x1		Long. 46cm
Racord Ojo Ø10mm		

Codigo	45-03-65	
		
Chevrolet D-Max 4x4 Derecha Delantera		
Hembra Rca Int. M10x1		Long. 45,5cm
Racord Ojo Ø10mm		

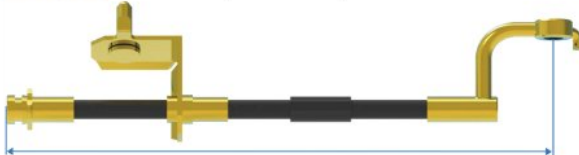
Codigo	45-03-66	
		
Chevrolet D-Max 4x4 Izquierda Delantera		
Hembra Rca Int. M10x1		Long. 45,5cm
Racord Ojo Ø10mm		

		
Racord Ojo Largo Curvo Ø10mm		
Hembra 10mm (Paso 1.0) x 34mm Con Ombligo		
Longitud	Descripcion	Codigo
42cm	Chevrolet Esteem Delantera	11-M532 / 45-03-42
49cm	Chevrolet Swift Chevitaxi 1.3 Delantera	11-M566 / 45-03-36

Codigo	11-M533	45-03-43
		
Chevrolet Esteem Trasera		
Hembra 10mm (Paso 1.0) x 34mm Con Ombligo		Long. 24cm
Hembra 10mm (Paso 1.0) x 34mm Con Ombligo		

Codigo	45-03-73	
		
Chevrolet Frr Bus/Camion Derecha Mod 2015-016 Freno		
Macho M10x1		Long. 66cm
Hembra M10x1		

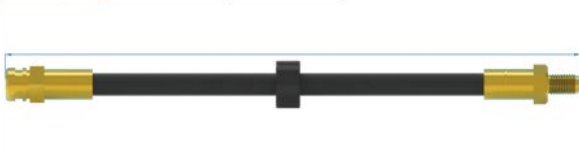
Codigo	45-03-70	
		
Chevrolet Frr Camion Delantera		
Macho M10x1		Long. 65cm
Hembra M10x1		

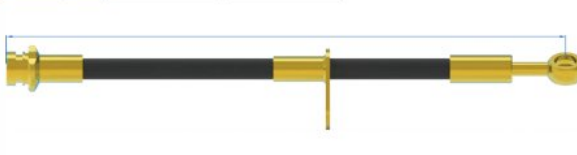
Codigo	45-03-86	
		
Chevrolet Gran Vitara Delantera		
Hembra M10x1		Long. 55cm
Racord Ojo Ø10mm		

Codigo	45-03-06	
		
Chevrolet Gmc Freno		
Macho 7/16"x20H		Long. 47,5cm
Hembra Rca. Ext. 3/8"x24H		

CHEVROLET

Manguera Freno

Codigo	11-M537	
		
Chevrolet Luv 2300 4X4 Trasera		
Racord Cuadrante Trooper		Long. 47,5cm
Hembra Hexagonal Fresada 10mm (paso 1.0) x 41mm con Ombliigo		

Codigo	11-M538	45-03-23
		
Chevrolet Luv 2300 4X2/Trooper Delantera		
Racord Ojo Largo Curvo Ø10mm		Long. 52cm
Hembra Hexagonal 10mm (paso 1.0) x 35.5mm con Ombliigo		

		
Hembra 10mm (Paso 1.0) x 34mm Con Ombliigo Racord Ojo y Gancho Ø10mm		
Longitud	Descripcion	Codigo
55,5cm	Chevrolet Luv 1600 Delantera	11-M535 / 45-03-22
44,5cm	Chevrolet Luv 2300 4X4/Trooper Ecuador Delantera	11-M536 / 45-03-39
46cm	Chevrolet Samurai Delantera	11-M554

		
Hembra 10mm (Paso 1.0) x 34mm Con Ombliigo Racor Cuadrante Trooper		
Longitud	Descripcion	Codigo
43,5cm	Chevrolet Luv 2300 4X2 Trasera	11-M539
44cm	Chevrolet Luv Todos Trasera	11-M540 / 45-03-21

Codigo	11-M541	
		
Chevrolet Malibu/Buik/Pontiac 74/76 Delantera		
Hembra Hexagonal 3/8" 24 NF x 41mm con Ombliigo		Long. 38,5cm
Racord Ojo Fresado Ø10mm		

Codigo	11-M544	45-03-54
		
Chevrolet Mini Blazer Derecha Delantera		
Hembra 10mm (paso 1.0) x 44.5mm Con Ombliigo		Long. 45,5cm
Racord Panela Mini Blazer Derecha		

Codigo	11-M545	45-03-55
		
Chevrolet Mini Blazer Izquierda Delantera		
Hembra 10mm (paso 1.0) x 44.5mm Con Ombliigo		Long. 46cm
Racord Panela Mini Blazer Izquierda		

Codigo	11-M546	45-03-25
		
Chevrolet Monza Larga M/Nuevo Delantera		
Hembra 10mm (paso 1.0) x 42.5mm sin Ombliigo		Long. 34,5cm
Racord Ojo Ø10mm Fresado		

Codigo	11-M547	45-03-24
		
Chevrolet Monza M/Viejo Delantera		
Racord Panela Ojo Ø11 mm Monza Todos		Long. 35cm
Hembra M10 x1.0 con Ombliigo		

Codigo	11-M548	
		
Chevrolet Monza Trasera		
Hembra 10mm (paso 1.0) x 42.5mm sin Ombliigo		Long. 22cm
Hembra 10mm (paso 1.0) x 42.5mm sin Ombliigo		

CHEVROLET

Manguera Freno

Codigo	45-03-88	
		
Chevrolet Nkr 1999 Delantera		
Hembra M10x1	Long.	36cm
Hembra M10x1		

Codigo	45-03-89	
		
Chevrolet Nkr y Nhr 98... Trasera		
Hembra M10x1	Long.	39,5cm
Hembra M10x1		

Codigo	11-M549	
		
Chevrolet Nkr / Nhr 98... Delantera		
Hembra Hexagonal 10mm (paso 1.0) x 35mm con Ombliigo	Long.	34cm
Hembra Hexagonal 10mm (paso 1.0) x 35mm con Ombliigo		

Codigo	45-03-52	
		
Chevrolet Npr Mod 97... Delantera		
Hembra M10x1	Long.	45cm
Hembra M10x1		

		
Hembra 10mm (paso 1.0) x 40mm con Ombliigo Macho 10mm (paso 1.0)		
Longitud	Descripcion	Codigo
32cm	Chevrolet Npr Corta Derecha Delantera	11-M550 / 45-03-08
45,5cm	Chevrolet Npr Larga Izquierda Delantera	11-M551 / 45-03-07 11-M551

		
Hembra Hexagonal 10mm (paso 1.0) x 35.5mm con Ombliigo Hembra Hexagonal 10mm (paso 1.0) x 35.5mm con Ombliigo		
Longitud	Descripcion	Codigo
45cm	Chevrolet Npr Hxh M/Nuevo Delantera	11-M552
40,5cm	Chevrolet Npr HxH Trasera	11-M553 / 45-03-09

Codigo	45-03-71	
		
Chevrolet Npr Freno		
Hembra M10x1	Long.	51cm
Hembra M10x1		

Codigo	45-03-75	
		
Chevrolet Npr Isuzu Mod 98-99 Central Trasera		
Hembra M10x1	Long.	40,6cm
Hembra M10x1		

Codigo	45-03-76	
		
Chevrolet Npr Isuzu Mod 99-2016 Izq-Der Trasera		
Hembra M10x1	Long.	40,3cm
Hembra M10x1		

Codigo	45-03-77	
		
Chevrolet Npr Isuzu Hd Mod 05-16 Izq-Der Delantera		
Racord Ojo Ø10mm	Long.	29,5cm
Hembra M10x1		

CHEVROLET

Manguera Freno

Codigo	45-03-80	
		
Chevrolet Npr Isuzu Hd 04-16 Izq-Der Delantera		
Hembra M10x1	Long.	33cm
Racord Ojo Ø10mm		

Codigo	11-M576	45-03-88
		
Chevrolet NKR Delantera		
Hembra 12mm (paso 1.0) Hexagonal con Omblico	Long.	36cm
Hembra 12mm (paso 1.0) Hexagonal con Omblico		

Codigo	11-M582	45-03-59
		
Chevrolet NKR 2005... / NHR Der - Izq Delantera		
Hembra Hexagonal 10mm (paso 1.0) x 35mm con Omblico	Long.	50cm
Hembra Hexagonal 10mm (paso 1.0) x 35.5mm con Omblico		

Codigo	11-M580	45-03-72
		
Chevrolet N-200 Delantera Delantera		
Macho 10mm (paso 1.0) x 40mm	Long.	38,5cm
Hembra 10mm (paso 1.0) x 34.5mm Con Omblico		

Codigo	11-M581	45-03-87
		
Chevrolet N-200 Trasera Trasera		
10mm (paso 1.0) x 34.5mm Hembra Con Omblico	Long.	42cm
Hembra 10mm (paso 1.0) x 34.5mm Con Omblico		

Codigo	11-M586	45-03-74
		
Chevrolet N-300, Van Cargo Todos Izq-Der. Delantera		
Hembra 10mm (paso 1.0) x 34.5mm Con Omblico	Long.	46,5cm
Racord Ojo Largo Curvo Ø10mm		

Codigo	11-M587	
		
Chevrolet N-300, Van Cargo Todos Izq-Der. Trasera		
Hembra 10mm (paso 1.0) sin Omblico	Long.	36,5cm
Hembra 10mm (paso 1.0) sin Omblico		

Codigo	11-M556	45-03-45
		
Chevrolet Rodeo Delantera		
Hembra 10mm (Paso 1.0) x 34mm Con Omblico	Long.	39cm
Racord Ojo y Gancho Ø10mm		

Codigo	45-03-46	
		
Chevrolet Rodeo Trasera		
Hembra Hexagonal M10x1	Long.	48cm
Racor Cuadrante Trooper		

Codigo	11-M555	45-03-51
		
Chevrolet Samurai Trasera		
Hembra 10mm (Paso 1.0) x 34mm Con Omblico	Long.	32,5cm
Racord Ojo y Gancho Ø10mm		

CHEVROLET

Manguera Freno

Codigo	45-03-90	
		
Chevrolet Sonic Delantera		
Hembra M10x1		Long. 40cm
Racord Panela Ojo Ø10 mm		

Codigo	45-03-91	
		
Chevrolet Sonic Trasera		
Hembra M10x1		Long. 26,8cm
Hembra M10x1		

Codigo	45-03-78	
		
Chevrolet Sail Trasera		
Hembra M10x1		Long. 23,2cm
Hembra M10x1		

Codigo	45-03-79	
		
Chevrolet Sail Delantera		
Hembra M10x1		Long. 38,5cm
Racord Ojo Ø10mm		

Codigo	45-03-92	
		
Chevrolet Spark Gt y Go Delantera		
Racord Ojo Ø10mm		Long. 25cm
Hembra M10x1		

Codigo	45-03-61	
		
Chevrolet Spark 7:24 Terminal Curvo Delantera		
Hembra M10x1		Long. 41,5cm
Terminal curvo - Ojo Ø10mm		

Codigo	45-03-61a	
		
Chevrolet Spark 7:24 Terminal Semicurvo Delantera		
Hembra M10x1		Long. 42,5cm
Terminal Semi-curvo - Ojo Ø10mm		

Codigo	45-03-40	
		
Chevrolet Super Carry 85-99 Delantera		
Hembra M10x1		Long. 57cm
Racord Ojo Ø10mm		

Codigo	45-03-41	
		
Chevrolet Super Carry 85-99 Trasera		
Hembra M10x1		Long. 27cm
Hembra M10x1		

Codigo	11-M561	
		
Chevrolet Super Carry Delantera		
Racord Ojo y Gancho Ø10mm		Long. 54,5cm
Hembra 10mm (Paso 1.0) x 34mm Con Obligo		

CHEVROLET

Manguera Freno

Codigo	11-M564	45-03-28	
			
Chevrolet Swift 1.100 - 1.300 Delantera			
Racord Ojo y Gancho Ø10mm		Long.	46cm
Hembra 10mm (Paso 1.0) x 34mm Con Ombligo			

Codigo	11-M565		
			
Chevrolet Swift 98... Trasera			
Hembra 10mm (Paso 1.0) x 34mm Con Ombligo		Long.	37,5cm
Hembra 10mm (Paso 1.0) x 34mm Con Ombligo			

Codigo	45-03-58		
			
Chevrolet Swift 1.3 Todos Trasera			
Hembra Rca Int. M10x1		Long.	55cm
Hembra Rca Int. M10x1			

Codigo	45-03-53		
			
Chevrolet S10 4X2 Mod 93-97 (Izq-Der) Delantera			
Racord Ojo Fresado Ø10mm		Long.	31cm
Hembra 3/8"x24h Con Ombligo			

Codigo	11-M591		
			
Chevrolet Tracker Trasera			
		Long.	

Codigo	11-M592		
			
Chevrolet Tracker Delantera			
Racord Ojo Largo Curvo Ø10mm		Long.	86,5cm
Racord 10mm paso 1.0			

Codigo	11-M567	45-03-30	
			
Chevrolet Trooper 10" Delantera			
Macho 10mm (paso 1.0) x 40mm		Long.	26cm
Hembra 10mm (paso 1.0) x 44.5mm Con Ombligo			

Codigo	11-M568	45-03-31	
			
Chevrolet Trooper Trasera			
Hembra 10mm (Paso 1.0) x 34mm Con Ombligo		Long.	29cm
Racord Ojo y Gancho Ø10mm			

Codigo	45-03-93		
			
Chevrolet Vitara Derecha Delantera			
Hembra M10x1		Long.	55cm
Racord Ojo Ø10mm			

Codigo	11-M569		
			
Chevrolet Vitara Larga Delantera			
Racord Ojo Largo Curvo Ø10mm		Long.	40,5cm
Hembra 10mm (Paso 1.0) x 34mm Con Ombligo			

CHEVROLET

Manguera Freno

Codigo	11-M570	45-03-50	
			
Chevrolet Vitara Siderick 93/99 Derecha Delantera			
Racord Ojo Largo Curvo Ø10mm			
Hembra 10mm (Paso 1.0) x 34mm Con Ombligo		Long.	52cm

Codigo	11-M571	45-03-49	
			
Chevrolet Vitara Siderick 93/99 Izquierda Delantera			
Racord 10mm paso 1.0			
Racord Ojo Largo Curvo Ø10mm		Long.	78,5cm

Codigo	11-M579	45-03-68/69	
			
Chevrolet Optra Der / Izq Delantera			
Racord Ojo Largo Ø10mm			
Hembra 10mm (paso 1.0) x 42.5mm sin Ombligo		Long.	44,5cm

Codigo	11-M572	45-03-38	
			
Chevrolet Wfr Delantera			
Hembra Hexagonal 10mm (paso 1.0) x 35.5mm Fresado con Ombligo			
Racord Ø10mm Ojo Pasador		Long.	40cm

Codigo	11-M585		
			
Chevrolet Zafira Delantera			
Racord Panela Ø10mm			
Hembra 10mm (paso 1.0) sin Ombligo		Long.	42,5cm

Bomba Vacio

Codigo	11-M574	36A-03-02	
			
Chevrolet Npr Modelo Nuevo Freno			
Racord Ojo Ø 10mm para Manguera 1/4			
Capsula para Manguera de 1/4		Long.	25cm

DAEWOO

Manguera Embrague

Codigo	22-M509	39-04-01	
			
Daewoo Racer/Cielo/Espero Embrague			
Racord Ø10mm Ojo y Gancho Daewoo			
Racord Embrague 10mm (paso 1.0) x 35mm Hexagonal con Ombligo Mazda		Long.	36cm

DAEWOO

Manguera Freno

Codigo	22-M502	
		
Daewoo Damas/Labo Delantera		
Racord Ojo Largo Curvo Ø10mm	Long.	55,5cm
Hembra 10mm (Paso 1.0) x 34mm Con Ombligo		

Codigo	22-M501	45-04-03
		
Daewoo Cielo Delantera		
Hembra 10mm (paso 1.0) x 42.5mm sin Ombligo	Long.	34,5cm
Racord Panela Ø10mm		

		
Hembra 10mm (Paso 1.0) x 34mm Con Ombligo Hembra 10mm (Paso 1.0) x 34mm Con Ombligo		
Longitud	Descripcion	Codigo
26cm	Daewoo Damas/Labo Trasera	22-M503
26cm	Daewoo Matiz Trasera	22-M505
23,5cm	Daewoo Tico Trasera	22-M514

		
Hembra 10mm (paso 1.0) x 42.5mm sin Ombligo Hembra 10mm (paso 1.0) x 42.5mm sin Ombligo		
Longitud	Descripcion	Codigo
25cm	Daewoo Racer Trasera	22-M508 / 45-04-01
24cm	Daewoo Tacuma Izquierda Delantera	22-M512

Codigo	22-M504	
		
Daewoo Matiz Delantera		
Racord Ojo Largo Curvo Ø10mm	Long.	46,5cm
Hembra 10mm (Paso 1.0) x 34mm Con Ombligo		

Codigo	22-M515	
		
Daewoo Nubira 1.6 / 2.0 16V Der-Izq Delantera Ø10mm Ojo Largo		
Hembra 10mm (paso 1.0) x 42.5mm sin Ombligo	Long.	41,5cm

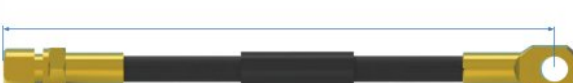
Codigo	22-M506	
		
Daewoo Racer Derecha Delantera		
Hembra 10mm (paso 1.0) x 42.5mm sin Ombligo	Long.	35cm
Racord Ojo Fresado Ø10mm		

Codigo	22-M507	45-04-02
		
Daewoo Racer Izquierda Delantera		
Racord Ojo Fresado Ø10mm	Long.	36cm
Racord M10 x 1		

		
Hembra 10mm (paso 1.0) x 42.5mm sin Ombligo Hembra 10mm (paso 1.0) x 42.5mm sin Ombligo		
Longitud	Descripcion	Codigo
25cm	Daewoo Racer Trasera	22-M508/ 45-04-41
24cm	Daewoo Tacuma Izquierda Delantera	22-M512

Codigo	22-M511	
		
Daewoo Tacuma Derecha Delantera		
Hembra 10mm (paso 1.0) x 42.5mm sin Ombligo	Long.	31,5cm
Hembra 10mm (paso 1.0) x 42.5mm sin Ombligo		

DAEWOO

Manguera Freno

Codigo	22-M513	45-04-04	
			
Daewoo Tico Delantera			
Ø10mm Ojo Largo Curvo			
Hembra 10mm (Paso 1.0) x 34mm Con Ombligo			Long. 45,5cm

DAIHATSU

Manguera Embrague

Codigo	39-05-01		
			
Daihatsu Delta Embrague			
Macho M10x1			Long. 29cm
Hembra M10x1			

Codigo	39-05-02		
			
Daihatsu Delta Diesel Embrague			
Hembra M10x1			Long. 32cm
Racord Ojo Ø10mm			

Codigo	31-M504	45-05-04L	
			
Daihatsu Delta Delantera			
Hembra 10mm (paso 1.0) x 44.5mm Con Ombligo			Long. 42,5cm
Embrague Macho16mm (paso 1.5) Hembra 10mm (paso1.0)			

Codigo	31-M505		
			
Daihatsu Delta Trasera			
Macho 10mm (paso 1.0)			Long. 45,5cm
10mm (paso 1.0) Hembra Hexagonal con Ombligo			

Codigo	45-05-06		
			
Daihatsu F-20 Mod 84... 74cm Delantera			
Macho M10x1			Long. 74cm
Hembra M10x1			

Codigo	31-M501		
			
Daihatsu ...79 Del-Tra			
Macho 10mm (paso 1.0) x 40mm			Long. 34cm
Hembra Hexagonal 10mm (paso 1.0) con Ombligo			

Codigo	31-M502	45-05-03	
			
Daihatsu 83... Delantera			
Macho 10mm (paso 1.0) x 40mm			Long. 68cm
Hembra 10mm (paso 1.0) x 44.5mm Con Ombligo			

Codigo	31-M503		
			
Daihatsu 80... Del-Tra			
Hembra 10mm (paso 1.0) x 44.5mm Con Ombligo			Long. 36,5cm
Hembra 10mm (paso 1.0) x 44.5mm Con Ombligo			

DAIHATSU

Manguera Embrague

Codigo	31-M506	45-05-01	
			
Daihatsu F10/F20 Del-Tra			
	Macho 10mm (paso 1.0) x 40mm	Long.	34,5cm
	Hembra 10mm (paso 1.0) x 44.5mm Con Omblogo		

Codigo	31-M507		
			
Daihatsu Rocky Mod 85 Delantera			
	Macho 10mm (paso 1.0) x 40mm	Long.	70cm
	Hembra 10mm (paso 1.0) x 44.5mm Con Omblogo		

Codigo	31-M508		
			
Daihatsu Delta Ojo x H Freno			
	Hembra 10mm (paso 1.0) x 34.5mm Con Omblogo	Long.	36cm
	Racord Ojo Largo Ø10mm		

Codigo	31-M509		
			
Daihatsu Feroza Delantera Freno			
	Hembra 10mm (paso 1.0) x 44.5mm Con Omblogo	Long.	58cm
	Racord Pin Ojo Ø10mm		

Codigo	45-05-02		
			
Daihatsu Mod Nuevo (HxH) Delantera			
	Macho M10x1	Long.	32cm
	Hembra M10x1		

DODGE

Manguera Freno

Codigo	19-M502		
			
Dodge 1500 Polara Larga Freno			
	Macho Largo 3/8" 24 NF x 48.5mm	Long.	38cm
	Macho Largo 3/8" 24 NF x 48.5mm		

Codigo	19-M504		
			
Dodge Alpine Delantera			
	Macho 10mm (paso 1.0) x 40mm	Long.	36,5cm
	Hembra 10mm (paso 1.0) sin Omblogo		

Codigo	45-06-04		
			
Dodge Dart Mod Nuevo Trasera			
	Hembra 3/8"x28H	Long.	34,5cm
	Panela Ojo Ø12mm - Rca. Int. 3/8"x28H		

Codigo	45-06-05		
			
Dodge Dart Mod Nuevo Larga Trasera			
	Hembra 3/8"x28H	Long.	57,5cm
	Panela Ojo Ø12mm - Rca. Int. 3/8"x28H		

DODGE

Manguera Freno

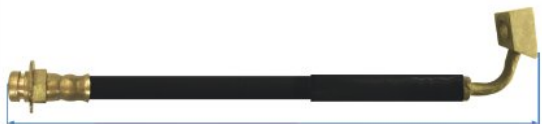
Codigo	45-06-12	
		
D-300 Mod 75-80 C1046 Curvo Delantera		
Hembra 3/8"x24H		Long. 35cm
Racord Panela Cuadrada Ojo Ø10mm		

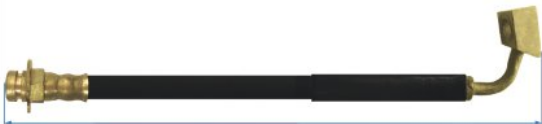
Codigo	45-06-12L	
		
Dodge Dart Mod 75-80 C-1046 Curvo 40cms Delantera		
Hembra 3/8"x24H		Long. 40cm
Racord Panela Cuadrada Ojo Ø10mm		

Codigo	45-06-14	
		
Dodge D100-300 Terminal Recto Delantera		
Hembra 3/8"x24H		Long. 46cm
Racord Panela Ojo Ø10 mm		

Codigo	19-M523	45-06-13
		
Dodge 100-300 70-74 Term. Curvo 46Cms Delantera		
Racord Panela Dodge 100/300 - 70/74		Long. 46cm
Hembra Fresada Hexagonal 3/8" 24 NF con Ombligo		

FIAT

Manguera Embrague

Codigo	15-M501	
		
Fiat 125 Polsky Embrague		
Macho 12mm (paso 1.25)		Long. 26cm
Hembra Hexagonal 12mm (paso 1.25) sin Ombligo		

Manguera Freno

		
Hembra 10mm (paso 1.25) x 39mm sin Ombligo		
Hembra Hexagonal Fresado 10mm (paso 1.0) x 35.5mm con Ombligo		
Longitud	Descripcion	Codigo
35,5cm	Fiat 125 Delantera	15-M502 / 45-07-01
28cm	Fiat 128 Delantera	15-M505 / 45-07-03
33cm	Fiat 131 Panorama / Mirafiori Delantera	15-M507 / 45-07-04
38,5cm	Fiat 132 Delantera	15-M509 / 45-07-05
38,5cm	Fiat Polsky Delantera	15-M515 / 45-07-01

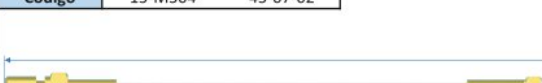
Codigo	15-M504	45-07-02
		
Fiat 125 Corta Trasera		
Hembra 10mm (paso 1.25) x 39mm sin Ombligo		Long. 17,5cm
Macho Corto 3/8" 24 NF x 39mm		

FIAT

Manguera Freno

		
Hembra 10mm (paso 1.25) x 39mm sin Ombligo Macho 10mm (paso 1.25) x 39mm		
Longitud	Descripcion	Codigo
29cm	Fiat 131 Panorama / Mirafiori Traserera	15-M508
32cm	Fiat 147 Delantera	15-M510 / 45-07-07

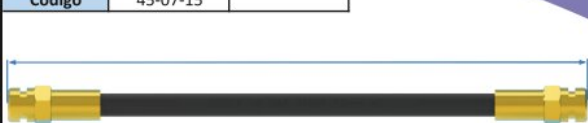
		
Fiat 128 Traserera		
Hembra M9x1.0 Con Ombligo	Long.	27,5cm
Hembra M9x1.0 Con Ombligo		

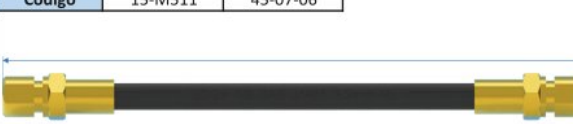
		
Fiat 147 Traserera		
Hembra 10mm (paso 1.25) x 39mm sin Ombligo	Long.	27cm
Hembra 10mm (paso 1.25) x 39mm sin Ombligo		

		
Fiat Premio y Otros Delantera		
Macho Rca M10x1.25	Long.	30cm
Hembra Rca. Ext. M10x1.25		

		
Fiat Premio Traserera		
Hembra 10mm (paso 1.25) x 39mm sin Ombligo	Long.	27,5cm
Racord Ojo Panela Ø10 mm		

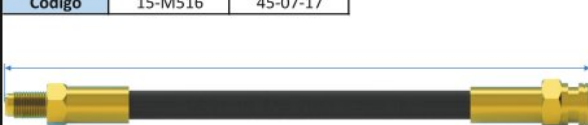
		
Fiat Uno/Premio Delantera		
Hembra 10mm (paso 1.0) x 38.5mm sin Ombligo	Long.	43cm
Macho 10mm (paso 1.0) x 40mm		

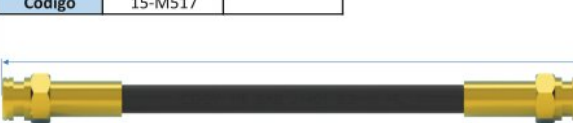
		
Fiat Uno Premio Traserera		
Hembra 10mm (paso 1.0) x 38.5mm sin Ombligo	Long.	25,5cm
Hembra 10mm (paso 1.0) x 38.5mm sin Ombligo		

		
Fiat Palio Siena Delantera		
Macho 10mm (paso 1.0) x 40mm	Long.	48,5cm
Hembra 10mm (paso 1.0) x 38.5mm sin Ombligo		

FORD

Manguera Freno

		
Ford 18" Largo Delantera		
Macho M11x1.25	Long.	46,5cm
Macho M10x1.0		

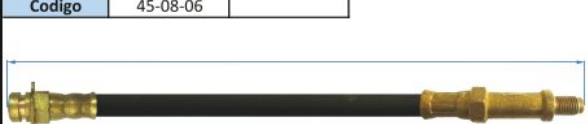
		
Ford 100 Mod 54-56 Larga 18" Delantera		
Hembra 3/8"x24h Con Ombligo	Long.	47cm
Macho M11 x 1.25		

FORD

Manguera Freno

Codigo	45-08-07	
		
Ford 100 Auto Mod 53-64 Delantera		
Macho 3/8" 24 NF Con Omblogo	Long.	46cm
Hembra 3/8"x24h Con Omblogo		

Codigo	45-08-08	
		
Ford 100/250 Mod 53-64 Delantera		
Macho M11x1.25	Long.	44cm
Hembra M11x1.0 Con Omblogo		

		
Hembra 3/8"x24H Panela Ojo Ø 9.5mm		
Longitud	Descripcion	Codigo
48cm	Ford 100/150 Mod 76-81 Izquierda Delantera	45-08-09
48cm	Ford 100/150 Mod 76-81 Derecha Delantera	45-08-10

		
Hembra Rca Int. 3/8"x28H Panela Ojo Ø10mm		
Longitud	Descripcion	Codigo
50cm	Ford 150 Lariat Mod 81-92 Izquierda Delantera	45-08-11
50cm	Ford 150 Lariat Mod 81-92 Derecha Delantera	45-08-12

Codigo	14-M505	
		
Ford 100/250 4X2 61-75 Delantera		
Macho Hexagonal 3/8" 24 NF x 71.7mm	Long.	47cm
Hembra Hexagonal 3/8" 24 NF x 41mm con Omblogo		

Codigo	45-08-28	
		
Ford 150/350 Mod 97-98 Trasera		
Panela Ojo Ø 11 mm Rca. Int. 7/16x	Long.	46cm
Hembra 3/8"x24H		

Codigo	45-08-37	
		
Ford 250 Mod 2002 Delantera		
Hembra 3/8"x24h Con Omblogo	Long.	54cm
Racord Panela Ojo Ø9.5mm		

Codigo	14-M515	
		
Ford 250/350 53-56 / Camion 55-57 / D100 41-56 Freno		
Macho Universal 7/16" 20 NF x 41mm	Long.	43cm
Macho 5/8" 18 NF - Hembra 7/16" 24 NF con Omblogo		

Codigo	14-M516	
		
Ford 250/350 68-72 Delantera		
Macho Hexagonal 7/16" x 20	Long.	51cm
Hembra Hexagonal 3/8" 24 NF x 41mm con Omblogo		

Codigo	45-08-15	
		
Ford 350 Mod Nuevo(Pin Racor) Delantera		
Hembra 3/8"x24H	Long.	50cm
Panela Ojo Ø 9.3mm		

FORD

Manguera Freno

Codigo	14-M518	45-08-29	
			
Ford 350 91... Derecha Delantera			
Racord Panela Ford Ø10mm			
Hembra Hexagonal Fresada 3/8" 24 NF con Ombligo		Long.	44cm

Codigo	14-M519		
			
Ford 350 91... Izquierda Delantera			
Racord Panela Ford Ø10mm			
Hembra Hexagonal Fresada 3/8" 24 NF con Ombligo		Long.	42cm

Codigo	14-M546		
Ford 150-350 Modelo Nuevo Delantera			
		Long.	

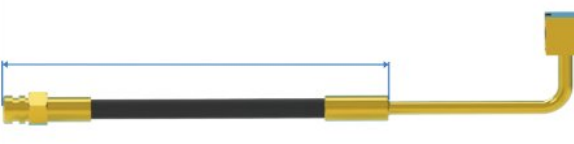
Codigo	14-M520	45-08-16	
			
Ford 350 M/Nuevo Delantera			
Panela 350 Freno Delantera			
Hembra Hexagonal Fresada 3/8" 24 NF con Ombligo		Long.	40cm

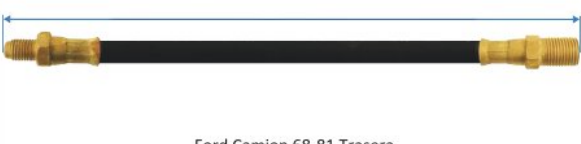
Codigo	14-M523	45-08-01	
			
Ford Camion 68-81 Trasera			
Macho M11x1.25			
Macho 5/8" 18 NF - Hembra 7/16" 24 NF con Ombligo		Long.	51cm

Longitud	Descripcion	Codigo
	Ford Ecosport Delantera	14-M544
	Ford Ecosport Trasera	14-M545

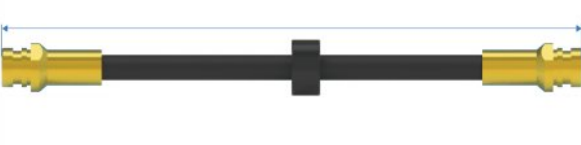
Codigo	45-08-38		
			
Ford Escape Trasera			
Hembra M10x1		Long.	27,5cm
Hembra M10x1			

Codigo	45-08-42		
			
Ford Escape Delantera			
Macho Rca.Ext. M10x1		Long.	46cm
Hembra M10x1			

Codigo	45-08-39		
			
Ford Explorer 2001 Delantera			
Racord Panela Ojo Ø 9.5mm			
Rosca 3/8X24H - Con Ombligo		Long.	44cm

Codigo	14-M543		
Ford Fiesta Trasera			
		Long.	

FORD

Manguera Freno

Codigo	14-M540	
		
Ford Festiva Der. Izq. Delantera		
Racord Ojo y Gancho Corto Ø10mm		
Hembra Hexagonal 10mm (paso 1.0) x 35mm con Ombligo	Long.	43,5cm

		
Racord Ford Festiva Macho 10mm (paso 1.0) x 49.5mm		
Longitud	Descripcion	Codigo
44,5cm	Ford Fiesta/Festiva Izquierda (Resorte 260mm) Delantera	14-M532 / 45-08-36
44,5cm	Ford Fiesta/Festiva Derecha (Resorte 260mm) Delantera	14-M533 / 45-08-37

Codigo	45-08-40	
		
Ford Laser 96/06 Delantera		
Hembra M10x1 Racord Ojo Ø10mm	Long.	43,5cm

Codigo	45-08-41	
		
Ford Laser 96/06 Trasera		
Hembra M10x1 Hembra M10x1	Long.	31,5cm

		
Panela Ojo Ø 9.7mm Hembra Curva Cda. Rca. Int. 3/8"x24H		
Longitud	Descripcion	Codigo
48,5cm	Ford Ranger 4x2 Mod 92-99 Derecha	45-08-34
48cm	Ford Ranger 4x2 Mod 92-99 Izquierda	45-08-35

HINO

Manguera Embrague

Codigo	39-00-01	
		
Hino Manguera Balinera Embrague		
Macho 3/8"x28h Macho 3/8"x28H	Long.	34cm

Codigo	39-00-02	
		
Hino Larga 42,5 cm Embrague		
Macho 3/8" x 24h Macho 3/8"x 28h	Long.	42,5cm

Manguera Freno

Codigo	45-30-10	
		
Hino Buseta Mod Nuevo (MxM) Delantera		
Macho M12x1.5 Macho M10x1	Long.	59cm

Codigo	45-30-11	
		
Hino Camion 7c Ojo Derecha Delantera		
Racord Ojo Ø10mm Hembra M10x1	Long.	67cm

HINO

Manguera Freno

Codigo	45-30-12	
		
Hino Camion 7c Ojo Izquierda Delantera		
Racord Ojo Ø10mm	Long.	67cm
Hembra M10x1		

Codigo	43-M501	
		
Hino Freno (Buseton) Delantera		
Macho Largo 10mm (paso 1.0) x 48.5mm	Long.	
Macho 12mm (paso 1.5)		

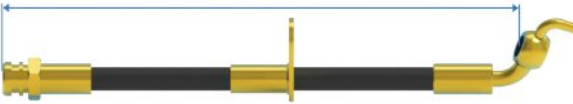
Codigo	43-M503	
		
Hino Fc/Gc Derecha- Izquierda 2000.. Freno		
Racord Ojo Curvo Ø10mm	Long.	61cm
Hembra Hexagonal 10mm (paso 1.0) x 35mm con Ombligo		

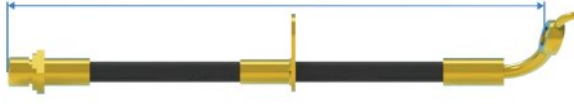
Codigo	45-30-02	
		
Hino Fc Mod 2009-2010 Delantera		
Hembra M10x1	Long.	60,5cm
Racord Ojo Ø10mm		

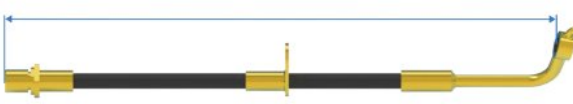
Codigo	45-30-13	
		
Hino Nutro 300 2005/2006 Delantera		
Racord Ojo Ø10mm	Long.	78cm
Hembra M10x1		

Codigo	45-30-03	
		
Hino Posterior FD Delantera		
Macho 12mm (paso 1.5)	Long.	
Macho M10 x 1.0		

Codigo	45-30-01	
		
Hino Super / 6D-6H Delantera		
Macho M12x1.5	Long.	57,5cm
Macho Rca. Extx M10x1		

Codigo	45-30-04	
		
Hino 1997 Motor 155 Sin Turbo Delantera		
Macho M12x1.5	Long.	49cm
Hembra M10x1		

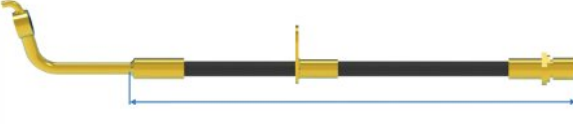
		
Rancord Gancho Ø10mm		
Hembra Fresado 10mm (paso 1.0) con Ombligo		
Longitud	Descripcion	Codigo
75cm	Hino 500 Modelo 2012 Derecha Delantera	45-30-05
75cm	Hino 500 Modelo 2012 Izquierda Delantera	45-30-06
68,5cm	Hino 716 Gancho Lado Derecha Delantera	45-30-08
68,5cm	Hino 716 Gancho Lado Izquierda Delantera	45-30-09

Codigo	45-30-07	
		
Hino 500 (MxM) 12mm 2012 Delantera		
Macho M12x1.5	Long.	55,5cm
Macho M10x1		

HONDA

Manguera Freno



Hembra M10x1
Racord Ojo Ø10mm

Longitud	Descripcion	Codigo
67,5cm	Honda Civic Mod 88-96 Izquierda Delantera	45-28-01
70cm	Honda Civic Mod 88-96 Derecha Delantera	45-28-02
75,5cm	Honda Accord Izquierda Delantera	45-28-03
76cm	Honda Accord Derecha Delantera	45-28-04



Hembra M10x1
Racord Ojo Ø10mm

Longitud	Descripcion	Codigo
56,4cm	Honda Civic Mod 12-15 Izquierda Delantera	45-28-09
56,4cm	Honda Civic Mod 12-15 Derecha Delantera	45-28-10
46,3cm	Honda Civic Mod 12-15 Izquierda Trasera	45-28-11
46,3cm	Honda Civic Mod 12-15 Derecha Trasera	45-28-12



Hembra M10x1
Racord Ojo Ø10mm

Longitud	Descripcion	Codigo
44,7cm	Honda CR-V Mod 02-16 Izquierda Delantera	45-28-05
44,7cm	Honda CR-V Mod 02-16 Derecha Delantera	45-28-06



Hembra M10x1
Racord Ojo Ø10mm

Longitud	Descripcion	Codigo
44,7cm	Honda CR-V Mod 02-16 Izquierda Trasera	45-28-07
44,7cm	Honda CR-V Mod 02-16 Derecha Trasera	45-28-08

HYUNDAI

Manguera Embrague

Codigo	27-M517	
		
Hyundai Accent Embrague		
Hembra 10mm (paso 1.0) x 34.5mm Con Ombigo	Long.	27cm
Hembra 10mm (paso 1.0) x 34.5mm Con Ombigo		

Manguera Freno



Racord Ojo Largo Curvo Ø10mm
Hembra 10mm (Paso 1.0) x 34mm Con Ombigo

Longitud	Descripcion	Codigo
53cm	Hyundai Accent Derecha Delantera	27-M501 / 45-09-02
53cm	Hyundai Accent Izquierda Delantera	27-M502 / 45-09-03

Codigo	27-M504	45-09-14
		
Hyundai Atos Derecha Delantera		
Racord Ojo Largo Curvo Ø10mm	Long.	27,5cm
Hembra 10mm (paso 1.0) sin Ombigo		

HYUNDAI

Manguera Freno

		
10mm (paso 1.0) x 34.5mm Hembra Con Omblogo Hembra Hexagonal Fresado 10mm (paso 1.0) x 35.5mm con Omblogo		
Longitud	Descripcion	Codigo
28cm	Hyundai Accent Trasera	27-M503
35cm	Hyundai Excel/Elenra 90/81 13.5" Superior Delantera	27-M508
35,5cm	Hyundai Excel/Pony Hxh Superior Delantera	27-M509
28cm	Hyundai Excel/Pony Trasera	27-M510

Codigo	27-M505	45-09-13
		
Hyundai Atos Izquierda Delantera		
Racord Ojo Largo Curvo Ø10mm		Long. 28cm
Hembra 10mm (paso 1.0) sin omblogo		

Codigo	45-09-22
	
Hyundai Camion HD-72 HD-64 (Izq-Der) Delantera	
Macho M10x1	Long. 47cm
Hembra M10x1	

Codigo	45-09-23
	
Hyundai Elantra Izquierda Mod 2007-2010 Trasera	
Hembra M10x1	Long. 31,1cm
Racord Ojo Largo Curvo Ø 10mm	

Codigo	45-09-24
	
Hyundai Elantra Derecha Mod 2007-2010 Trasera	
Hembra M10x1	Long. 31,1cm
Racord Ojo Ø10mm	

Codigo	27-M506	45-09-11
		
Hyundai Elantra Derecha Delantera		
Racord Ojo Largo Curvo Ø10mm		Long. 52cm
Hembra 10mm (Paso 1.0) x 34mm Con Omblogo		

Codigo	27-M507	45-09-12
		
Hyundai Elantra Izquierda Delantera		
Racord Ojo Largo Curvo Ø10mm		Long. 52cm
Hembra 10mm (Paso 1.0) x 34mm Con Omblogo		

Codigo	45-09-27
	
Hyundai Grand i10 (Izq-Der) Delantera	
Hembra M10x1	Long. 35,5cm
Racord Ojo Ø10mm	

		
Racord Ojo Largo Curvo Ø10mm Hembra 10mm (paso 1.0) sin Omblogo		
Longitud	Descripcion	Codigo
55,5cm	Hyundai Gran Starex Izquierda Delantera	27-M523 / 45-09-19
55,5cm	Hyundai Gran Stares Derecha Delantera	27-M524 / 45-09-18

Codigo	45-09-10
	
Hyundai H100 Van Grace (Izquierda- Derecha) Delantera	
Hembra 10mm (paso 1.0) x 34.5mm Con Omblogo	Long. 26,5cm
Hembra 10mm (paso 1.0) x 34.5mm Con Omblogo	

HYUNDAI

Manguera Freno

Codigo	27-M512	
		
Hyundai H100 Inferior Delantera		
Hembra 10mm (paso 1.0) x 34.5mm Con Ombliigo	Long.	21,5cm
Macho 10mm (paso 1.0) x 40mm		

Codigo	27-M513	
		
Hyundai H100 Superior Delantera		
Hembra Hexagonal Fresada 10mm (paso 1.0) x 41.mm con Ombliigo	Long.	31,5cm
Hembra Hexagonal Fresada 10mm (paso 1.0) x 41.mm con Ombliigo		

Codigo	27-M514	
		
Hyundai H100 Trasera		
Hembra Hexagonal 10mm (paso 1.0) x 35mm con Ombliigo	Long.	33cm
Hembra Hexagonal 10mm (paso 1.0) x 35mm con Ombliigo		

Codigo	27-M525	45-09-25
		
Hyundai i10 Delantera		
Racord Ojo Largo Curvo Ø10mm	Long.	35cm
Hembra 10mm (paso 1.0) sin Ombliigo		

Codigo	27-M526	45-09-26
		
Hyundai i10 Trasera		
Hembra 10mm (paso 1.0) sin Ombliigo	Long.	30cm
Hembra 10mm (paso 1.0) sin Ombliigo		

Codigo	27-M527	
		
Hyundai i35 Delantera		
Racord Ojo 10mm	Long.	0
Hembra 10mm (paso 1.0) sin Ombliigo		

Codigo	27-M528	
		
Hyundai i25 Delantera		
	Long.	

		
Racord Ojo Largo Curvo Ø10mm Hembra 10mm (paso 1.0) sin Ombliigo		
Longitud	Descripcion	Codigo
55cm	Hyundai i25 Izquierda II Serie Delantera	27-M529
55cm	Hyundai i25 Derecha II Serie Delantera	27-M530

Codigo	27-M532	
		
Hyundai i25 Trasera		
Racord Ojo y Gancho Corto Ø10mm	Long.	33cm
Hembra Hexagonal 10mm (paso 1.0) x 35mm con Ombliigo		

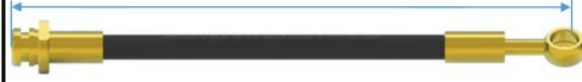
Codigo	27-M515	45-09-01
		
Hyundai Pony (Ojo) Inf. Delantera		
Racord Ojo Largo Ø10mm	Long.	24,5cm
Hembra 10mm (Paso 1.0) x 34mm Con Ombliigo		

HYUNDAI

Manguera Freno

Codigo	45-09-20	
		
Hyundai Starex Mod 2008/2009 Delantera		
Hembra M10x1		
Racord Ojo Ø10mm	Long.	34,5cm

Codigo	27-M531	
		
Hyundai Santa Fe Trasera		
	Long.	

		
Racord Ojo Curvo Ø10mm Hembra 10mm (paso 1.0)		
Longitud	Descripcion	Codigo
33cm	Hyundai Starex Derecha Delantera	27-M519
35,5cm	Hyundai Starex Izquierda Delantera	27-M520 / 45-09-21

		
Racord Ojo Curvo Ø10mm Hembra 10mm (paso 1.0)		
Longitud	Descripcion	Codigo
35,5cm	Hyundai Starex Derecha 2010... Delantera	45-09-28
35cm	Hyundai Starex Izquierda 2010... Delantera	45-09-29

Codigo	27-M518	
		
Hyundai Tata 2002... Delantera		
Racord Ojo Largo Ø10mm		
Hembra Hexagonal 10mm (paso 1.0) x 35.5mm con Omblogo	Long.	49,5cm

Codigo	27-M516	
		
Hyundai Vacio Freno		
Racord Ojo Largo Ø10mm		
Racord Ojo Largo Ø10mm	Long.	27cm

		
Hembra Rca. 3/8"X24h Racord Ojo Ø10mm		
Longitud	Descripcion	Codigo
46cm	Hyundai Tucson Derecha Delantera	45-09-16
45cm	Hyundai Tucson Izquierda Delantera	45-09-17

Filtro de Aceite

Codigo	36A-09-01	
		
Hyundai Manguera Desaster 2,5 Diesel H-100 Filtro Aceite		
Racord Ojo Ø10mm		
Racord Ojo Ø10mm	Long.	18cm

JAC

Manguera Freno de Aire

Codigo	44-32-01	
		
Jac Todos Delantera Izq-Der Freno Aire		
Hembra M16x15	Long.	53cm
Hembra M16x15		

Manguera Freno

		
Hembra M16x15 Hembra M16x15		
Longitud	Descripcion	Codigo
52cm	Jac Todos (Izq-Der) Delantera	45-32-01
40cm	Jac Todos (Izq-Der) Trasera	45-32-02

KENWORTH

Manguera Freno de Aire

Codigo	44-38-01	
		
Kenworth Delantera Freno Aire		
	Long.	50cm

KIA

Manguera Embrague

Codigo	29-M501	
		
Kia 3500 Embrague		
Macho 16mm (paso 1.5) - Hembra 10mm (paso1.0)	Long.	35,5cm
Macho 16mm (paso 1.5) - Hembra 10mm (paso1.0)		

Codigo	29-M519	
		
Kia Besta Embrague		
Hembra Hexagonal 10mm (paso 1.0) x 35mm con Ombligo	Long.	35,5cm
Racord Ojo y Gancho Ø10mm		

Manguera Embrague

Codigo	45-12-04	
		
Kia Asia Topic Combi Ceres 3500/3600 BombaVacio		
Hembra M12x1.5	Long.	29,5cm
Racord Ojo Ø10mm		

Codigo	29-M502	
		
Kia Besta Delantera		
Racord Ojo y Gancho Corto Ø10mm	Long.	38,5cm
Hembra 10mm (paso 1.0) x 34.5mm Con Ombligo		

KIA

Manguera Freno

Codigo	45-12-03	
		
Kia Asia Topic Delantera		
Hembra Hexagonal M10x1	Long.	32cm
Racord Pin Gancho Ø10mm		

Codigo	29-M503	
		
Kia Besta 14" Traseira		
Macho largo 3/8" 24 NF x 55mm	Long.	37cm
Hembra 3/8" 24 NF x 37mm Con Ombligo		

Codigo	29-M515	
		
Kia Besta Bomba Vacio Bomba Vacio		
Racord Ojo Largo Ø10mm	Long.	28cm
Racord Ojo Largo Ø10mm		

Codigo	45-12-09	
		
Kia Carnival Izquierda Delantera		
Hembra M10x1.0 Con Ombligo	Long.	58cm
Racord Panela Ø10mm		

Codigo	29-M517	
		
Kia Carnival Bomba Vacio		
Racord Ojo Ø10mm Manguera 1/4	Long.	33,5cm
Capsula Manguera de 1/4		

Codigo	29-M504	45-12-10
		
Kia Carnival Derecha Delantera		
Racord Panela Derecha	Long.	49,5cm
Hembra Hexagonal Fresado 10mm (paso 1.0) x 35.5mm con Ombligo		

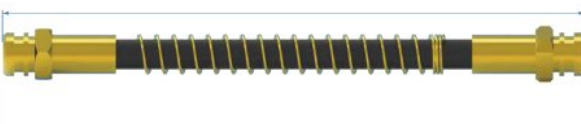
Codigo	29-M506	45-12-11
		
Kia Carnival Trasera		
Hembra Hexagonal Fresado 10mm (paso 1.0) x 35.5mm con Ombligo	Long.	30cm
Hembra Hexagonal Fresado 10mm (paso 1.0) x 35.5mm con Ombligo		

Codigo	29-M526	
		
Kia Cerato Izquierda Delantera		
	Long.	

Codigo	29-M527	
		
Kia Cerato Derecha Delantera		
	Long.	

Codigo	29-M528	
		
Kia Cerato Trasera		
	Long.	

KIA

Manguera Freno

Codigo	29-M507	45-12-08	
			
Kia Ceres 4X2 Delantera			
Hembra Hexagonal 10mm (paso 1.0) x 35mm con Ombligo		Long.	36cm
Macho corto 10mm (paso 1.0) x 39mm			

Codigo	29-M520		
			
Kia Gran Pregio Delantera			
Racord Fresado 10mm (paso 1.0) x 35.5mm con Ombligo		Long.	55cm
Racord Ojo Pasador Ø10mm			

Codigo	45-13-01		
			
Kia Master Copa Macho Delantera			
Hembra 3/8" 24 NF x 37mm Con Ombligo		Long.	36cm
Macho largo 3/8" 24			

Codigo	45-13-02		
			
Kia Master Copa x Copa Delantera			
Hembra 10mm (paso 1.25) x 39mm sin Ombligo		Long.	38cm
Hembra 10mm (paso 1.25) x 39mm sin Ombligo			

			
Hembra M10x1 Hembra M10x1			
Longitud	Descripcion	Codigo	
26cm	Kia Picanto Izquierda Trasera	45-12-13	
27cm	Kia Picanto Derecha Trasera	45-12-14	

Codigo	29-M522		
			
Kia Picanto Ion Del - Izq Delantera			
Racord Ojo Ø10mm		Long.	43cm
Hembra 10mm (paso 1.0) sin Ombligo			

Codigo	29-M523		
			
Kia Picanto Trasera			
Hembra 10mm (paso 1.0) sin Ombligo		Long.	30cm
Hembra 10mm (paso 1.0) sin Ombligo			

Codigo	29-M518	45-12-15/16	
			
Kia Picanto Delantera Der - Izq Delantera			
Racord Ojo Largo Curvo Ø10mm		Long.	31cm
Hembra 10mm (paso 1.0) sin Ombligo			

Manguera Embrague

Codigo	29-M516	45-12-18	
			
Kia Pregio 98... Delantera			
Hembra Hexagonal M10x1		Long.	54cm
Racord Panela Ø10mm			

Codigo	29-M529		
			
Kia Pregio Derecha - Izquierda Delantera			
Racord Panela Ø10mm		Long.	52,3cm
Hembra M10x1.0 con Ombligo			

KIA

Manguera Embrague



Hembra M10x1 Racord Ojo Ø10mm		
Longitud	Descripcion	Codigo
54,9cm	Kia Picanto Izquierda Trasera	45-12-23
54,9cm	Kia Picanto Derecha Trasera	45-12-24



Hembra M10x1 Hembra M10x1		
Longitud	Descripcion	Codigo
26cm	Kia Picanto Izquierda Trasera	45-12-13
27cm	Kia Picanto Derecha Trasera	45-12-14

Codigo	29-M514	45-12-17
--------	---------	----------



Kia Rio Delantera		
Racord Ojo Largo Curvo Ø10mm		
Hembra 10mm (paso 1.0) sin Ombligo		Long. 52cm



Hembra M10x1 Racord Ojo Ø10mm		
Longitud	Descripcion	Codigo
57cm	Kia Rio 2012-2017 Izquierda Delantera	45-12-19
57cm	Kia Rio 2012-2017 Derecha Delantera	45-12-20

Codigo	45-12-01
--------	----------



Kia Sanfer Delantera		
Macho 10mm (paso 1.0) x 40mm		Long. 54cm
Hembra M10x1.0 Sin Ombligo		

Codigo	29-M510	45-12-12
--------	---------	----------



Kia Sephia Delantera		
Macho 10mm (paso 1.0) x 40mm		Long. 47,5cm
Hembra 10mm (paso 1.0) x 38.5mm sin Ombligo		



Hembra M10x1 Racord Ojo Ø10mm		
Longitud	Descripcion	Codigo
54cm	Kia Soul 2010-2013 Izquierda Delantera	45-12-21
54cm	Kia Soul 2010-2013 Derecha Delantera	45-12-22



Hembra M10x1 Racord Ojo Ø10mm		
Longitud	Descripcion	Codigo
53,4cm	Kia Soul 2014-2019 Izquierda Delantera	45-12-25
53,4cm	Kia Soul 2014-2019 Derecha Delantera	45-12-26

Codigo	45-12-27
--------	----------

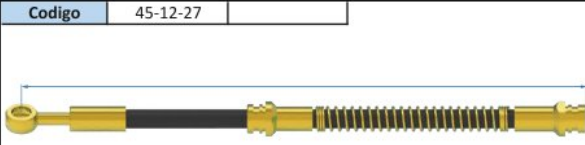

Kia Sportage Revolution Delantera		
Racord Ojo Ø10mm		Long. 45,1cm
Hembra M10x1		

Codigo	29-M511	45-12-06
--------	---------	----------



Kia Sportage Derecha Delantera		
Racord Derecho Espigo Largo Ø10mm (paso 1.0)		Long. 45,5cm
Racord (paso 1.0)		

KIA

Manguera Embrague

Codigo	29-M512	45-12-05		
				
Kia Sportage Izquierda Delantera				
Racord (paso 1.0)				
Racord Izquierdo Espigo Largo Ø10mm (paso 1.0)	Long.	45,5cm		

Codigo	29-M513	45-12-07		
				
Kia Sportage Trasera				
Macho M10x1.0				
Hembra Hexagonal 10mm (paso 1.0) x 35mm con Ombligo	Long.	0		

LADA

Manguera Embrague

Codigo	20-M501	39-07-01		
				
Lada 2104/Niva Embrague				
Macho 12mm (paso 1.25)				
Hembra Hexagonal 12mm (paso 1.25) sin Ombligo	Long.	26cm		

Manguera Freno

				
Hembra M10x1 Racord Ojo Ø10mm				
Longitud	Descripcion	Codigo		
31cm	Lada 1600 Delantera	45-07-09		
57cm	Lada 2121 Delantera	45-07-10		

Codigo	20-M503			
				
Lada 2104 Trasera				
Hembra 10mm (paso 1.25) x 39mm sin Ombligo	Long.	31,5cm		
Macho 10mm (paso 1.25) x 39mm				

Codigo	20-M506			
				
Lada Samara Delantera				
Hembra 10mm (paso 1.25) x 39mm con Ombligo	Long.	35cm		
Macho 10mm (paso 1.25) x 41mm				

				
Hembra 10mm (paso 1.25) x 39mm sin Ombligo Racord Ojo Fresado Ø10mm				
Longitud	Descripcion	Codigo		
32,5cm	Lada 2104 Delantera	20-M502		
55cm	Lada Niva Larga Delantera	20-M504		
50,5cm	Lada Niva Corta Delantera	20-M505		

LAND ROVER

Manguera Embrague

Codigo	39-14-01			
				
Land Rover Mod 86... Embrague				
Macho M11x1.25	Long.	24cm		
Macho M11x1.25				

Codigo	45-14-01			
				
Land Rover Delantera				
Macho 3/8"x4H	Long.	41cm		
Hembra 3/8"x24H				

LAND ROVER

Manguera Freno

Codigo	45-14-02	
		
Land Rover Mod 85... Delantera		
Macho M10x1.0		Long. 38cm
Macho M10x1.0		

MAZDA

Manguera Embrague

Codigo	12-M528	
		
Mazda Allegro S/W Embrague		
Hembra Hexagonal 10mm (paso 1.0) x 35mm con Omblico		Long. 36cm
Hembra Hexagonal 10mm (paso 1.0) x 35mm con Omblico		

Codigo	12-M502	45-16-12
		
Mazda B1600 35cm Trasera Embrague		
Hembra 10mm (paso 1.25) x 39mm con Omblico		Long. 35cm
Macho 10mm (paso 1.25) x 41mm		

		
Hembra Hexagonal Fresado 10mm (paso 1.0) x 35.5mm con Omblico		
Hembra Hexagonal Fresado 10mm (paso 1.0) x 35.5mm con Omblico		
Longitud	Descripcion	Codigo
20,5cm	Mazda 323 Embrague	12-M501 / 39-16-01
18cm	Mazda B2000 Corta Embrague	12-M504 / 39-16-06

Codigo	12-M503	39-16-04
		
Mazda B2000/B2200 Larga Embrague		
Macho 10mm (paso 1.0) x 40mm		Long. 70,5cm
Hembra 10mm (paso 1.0) x 35mm Hexagonal con Omblico		

Codigo	12-M505	
		
Mazda Matsuri Hxh Embrague		
Hembra Hexagonal 10mm (paso 1.0) x 35mm con Omblico		Long. 28,5cm
Hembra Hexagonal 10mm (paso 1.0) x 35mm con Omblico		

Codigo	12-M505a	39-16-03
		
Mazda Turbo Diesel T45 Embrague		
Hembra Hexagonal 10mm (paso 1.0) x 35mm con Omblico		Long. 35cm
Hembra Hexagonal 10mm (paso 1.0) x 35mm con Omblico		

Codigo	39-16-02	
		
Bomba Auxiliar Embrague Mazda T-45 (Ojo X Ojo)		
Racord Ojo Ø10mm		Long. 23cm
Racord Ojo Ø10mm		

MAZDA

Manguera Freno

Codigo	12-M529	
Mazda 2 Delantera		
	Long.	

Codigo	12-M530	45-16-27
Mazda 2 Trasera		
Hembra M10 x 1.0 Con Ombligo	Long.	29,5cm
Hembra M10 x 1.0 Con Ombligo		

Codigo	12-M531	45-16-21
Mazda 3 Delantera		
Macho M10 x 1.0	Long.	47cm
Hembra M10 x 1.0 Sin Ombligo		

Codigo	12-M532	
Mazda 3 Trasera		
	Long.	

Codigo	45-16-01	
Mazda 323 Mod 84-85 (Pin) Delantera		
Hembra M10x1	Long.	47cm
Racord Ojo Ø10mm		

Codigo	45-16-06	
Mazda 363 Mod 90... (Gancho) Delantera		
Hembra M10x1	Long.	43cm
Racord Ojo Ø10mm		

Racord Ojo y Gancho Corto Ø10mm		
Hembra Hexagonal 10mm (paso 1.0) x 35mm con Ombligo		
Longitud	Descripcion	Codigo
46cm	Mazda 323 84/85 Delantera	12-M509 / 45-16-03
44,5cm	Mazda Allegro 1.3 Delantera	12-M515 / 45-16-25
42,5cm	Mazda 323 86/90 Delantera	12-M507 / 45-16-04

Hembra Hexagonal 10mm (paso 1.0) x 35mm con Ombligo		
Hembra Hexagonal 10mm (paso 1.0) x 35mm con Ombligo		
Longitud	Descripcion	Codigo
31cm	Mazda 323 86-90 Trasera	12-M508 / 45-16-05
26cm	Mazda 323 84/85 Trasera	12-M510 / 45-16-02
29cm	Mazda 626 Trasera	12-M513 / 45-16-09
40cm	Mazda Turbo Diesel T45 Delantera	12-M524 / 45-16-15

Codigo	12-M511	45-16-07
Mazda 323 Corta Delantera		
Racord Ojo y Gancho Corto Ø10mm	Long.	30cm
Hembra Hexagonal 10mm (paso 1.0) x 35mm con Ombligo		

Codigo	45-16-08	
Mazda 626 (Gancho) Delantera		
Hembra M10x1	Long.	56cm
Racord Ojo Ø10mm		

MAZDA

Manguera Freno

Codigo	12-M512	
		
Mazda 626 Delantera		
Hembra Hexagonal 10mm (paso 1.0) x 35mm con Ombligo	Long.	53,5cm
Racord Ojo y Gancho Corto Ø10mm		

Codigo	12-M512A	
		
Mazda 626 Importada Matsuri Delantera		
Hembra Hexagonal Fresado 10mm (paso 1.0) x 35.5mm con Ombligo	Long.	51,5cm
Macho corto 10mm (paso 1.0) x 39mm		

Codigo	12-M526	45-16-10
		
Mazda 626 PIN Delantera		
Hembra Hexagonal 10mm (paso 1.0) x 35mm con Ombligo	Long.	57cm
Racord Pin Ojo Ø10mm		

		
Racord Ojo y Gancho Corto Ø10mm		
Hembra Hexagonal Fresado 10mm (paso 1.0) x 35.5mm con Ombligo		
Longitud	Descripcion	Codigo
43,5cm	Mazda Alegre M/Nuevo Delantera	12-M514
46,5cm	Mazda B2600 4X2 Delantera	12-M521 / 45-16-24

		
Hembra Hexagonal Fresado 10mm (paso 1.0) x 35.5mm con Ombligo		
Hembra Hexagonal Fresado 10mm (paso 1.0) x 35.5mm con Ombligo		
Longitud	Descripcion	Codigo
31cm	Mazda Alegre 1.3 Trasera	12-M516 / 45-16-26
35cm	Mazda B2000/B2200/B2600 Trasera	12-M522

		
Racord Ojo y Gancho Corto Ø10mm		
Hembra Hexagonal Fresado 10mm (paso 1.0) x 35.5mm con Ombligo		
Longitud	Descripcion	Codigo
52,5cm	Mazda B2000 Mod. 90 Delantera	12-M518 / 45-16-17
51,5cm	Mazda B2200 Delantera	12-M520 / 45-16-14

Codigo	12-M517	45-16-11
		
Mazda B1600 Delantera		
Hembra 10mm (paso 1.25) x 39mm con Ombligo	Long.	45cm
Macho 10mm (paso 1.25) x 41mm		

Codigo	12-M519	45-16-13
		
Mazda B2000 Pin Delantera		
Hembra Hexagonal Fresado 10mm (paso 1.0) x 35.5mm con Ombligo	Long.	58,5cm
Racord Pin Ojo Ø10mm		

Codigo	45-16-22	
		
Mazda B2500 Mod 2000-2006 Delantera		
Hembra M10x1	Long.	51cm
Racord Ojo Ø10mm		

Codigo	45-16-18	
		
Mazda B2600 Mod 91... Delantera		
Hembra M10x1	Long.	49cm
Racord Ojo Ø10mm		

MAZDA

Manguera Freno

Codigo	12-M527	45-16-20	
			
Mazda BT-50 Delantera			
Racord Ojo y Gancho Corto Ø10mm		Long.	43cm
Hembra 10mm (paso 1.25) x 39mm con Ombligo			

Codigo	45-16-19		
			
Mazda BT-50 Ford Ranger 4x2 Mod 2004-2012 Delantera			
Hembra M10x1		Long.	52cm
Racord Ojo Ø10mm			

Codigo	45-16-23		
			
Mazda / Ford / Honda ABS Delantera			
Racord Ojo Ø10mm		Long.	42,5cm
Hembra M10x1			

Codigo	12-M523		
			
Mazda Matsuri Delantera			
Racord Ojo y Gancho Corto Ø10mm		Long.	51,5cm
Hembra Hexagonal 10mm (paso 1.0) x 35mm con Ombligo			

Manguera Lubricación

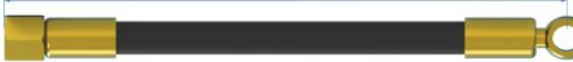
Codigo	45-16-16		
			
Mazda T-45 Turbo (Lubricación) Lubricación			
Hembra M12x1.5		Long.	19cm
Racord Ojo Ø10mm			

Bomba Vacio

Codigo	12-M525	36A-16-01	
			
Mazda T-45 12" Bomba Vacio			
Racord Ojo Ø10mm para Manguera de 1/4		Long.	30,5cm
Capsula para Manguera de 1/4			

MERCEDES BENZ

Manguera Freno

Codigo	45-17-01		
			
Mercedes Benz Sprinter Buseta Delantera			
Macho M10x1		Long.	41,5cm
Hembra M10x1			

Codigo	45-17-02		
			
Mercedes Benz-Bmw Modelo Viejo Delantera			
Hembra 10mm (paso 1.0) sin Ombligo		Long.	
Hembra 10mm (paso 1.0) sin Ombligo			

MITSUBISHI

Manguera Embrague

Codigo	39-19-01	
		
Mitsubishi Canter - Fusi Embrague		
Macho M10x1	Long.	27,5cm
Hembra M10x1		

Codigo	21-M527	
		
Mitsubishi Canter Bomba Auxiliar Embrague		
Macho 12mm (paso 1.0) con Ombigo	Long.	43cm
Hembra Hexagonal 12mm (paso 1.0) con Ombigo		

Manguera Freno

		
Hembra Hexagonal 10mm (paso 1.0) x 35mm con Ombigo Hembra Hexagonal 10mm (paso 1.0) x 35mm con Ombigo		
Longitud	Descripcion	Codigo
23,5cm	Mitsubishi Estándar Inferior Delantera	21-M501
37cm	Mitsubishi Estándar 5 Ptas. Central Trasera	21-M502
26,5cm	Mitsubishi Hardtop ...95 Inferior Delantera	21-M504
35cm	Mitsubishi Hardtop Central Trasera	21-M505
33cm	Mitsubishi L 200 Delantera	21-M507
38cm	Mitsubishi L 200 Trasera	21-M508
28,5cm	Mitsubishi L 300 Corta Inferior Delantera	21-M510 / 45-19-03

		
Macho 10mm (paso 1.0) x 40mm Hexagonal Fresada 10mm (paso 1.0) x 41mm con Ombigo		
Longitud	Descripcion	Codigo
22cm	Mitsubishi Montero Hxm Superior	21-M512 / 45-19-01
25,4cm	Mitsubishi Montero 10" Mxh Delantera	21-M514
30,5cm	Mitsubishi Montero 12" Mxh Delantera	21-M516
41cm	Mitsubishi Montero 16" Mxh Delantera	21-M518
51cm	Mitsubishi Montero 20" Mxh Delantera	21-M520
29,5cm	Mitsubishi L 300 Hxm Delantera	21-M526

		
Macho 10mm (paso 1.0) x 40mm Hembra Hexagonal 10mm (paso 1.0) x 35mm con Ombigo		
Longitud	Descripcion	Codigo
26cm	Mitsubishi Hardtop ...95 Superior Delantera	21-M503
28,5cm	Mitsubishi L 300 Larga Superior Delantera	21-M509

		
Racord Ojo y Gancho Ø 10mm Hembra 10mm (paso 1.0) x 34.5mm Con Ombigo		
Longitud	Descripcion	Codigo
43,5cm	Mitsubishi Lancer Derecha Delantera	21-M506 / 45-19-04
46cm	Mitsubishi Lancer Izquierda Delantera	45-19-05

Codigo	45-19-09	
		
Mitsubishi Lancer MxH Delantera		
Hembra M10x1.0 Sin Ombigo	Long.	35cm
Macho 10mm (paso 1.0) x 40mm		

Codigo	45-19-11	
		
Mitsubishi Canter Fuso Izq-Der Delantera		
Macho M10X1	Long.	40cm
Hembra M10X1		

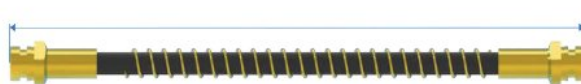
Codigo	45-19-06	
		
Mitsubishi L 200 Montero Trasera		
Hembra M10x1	Long.	36cm
Hembra M10x1		

Codigo	21-M511	45-19-07
		
Mitsubishi L300 Trasera		
Hembra Hexagonal 10mm (paso 1.0) x 35mm	Long.	42,5cm
Hembra Hexagonal 10mm (paso 1.0) x 35mm		

MITSUBISHI

Manguera Freno

Codigo	45-19-08			
				
Mitsubishi Montero Delantera				
	Macho M10x1	Long.	46cm	
	Hembra M10x1			

Codigo	45-19-10			
				
Mitsubishi Montero Central Trasera				
	Macho 3/8"x24H	Long.	40cm	
	Macho 3/8"x24H			

Codigo	21-M515			
				
Mitsubishi Montero 11" Mxh Delantera				
	Macho 10mm (paso 1.0) x 40mm	Long.	28cm	
	Hembra Hexagonal Fresado 10mm (paso 1.0) x 35.5mm con Ombligo			

Codigo	21-M517			
				
Mitsubishi Montero 14" Mxh Delantera				
	Macho 10mm (paso 1.0) x 40mm	Long.	35,6cm	
	Hexagonal Fresada 10mm (paso 1.0) x 41.mm con Ombligo			

				
Hexagonal Fresada 10mm (paso 1.0) x 41.mm con Ombligo Hexagonal Fresada 10mm (paso 1.0) x 41.mm con Ombligo				
Longitud	Descripción	Codigo		
22cm	Mitsubishi Montero Hxh Trasera	21-M513 / 45-19-02		
30,5cm	Mitsubishi Montero 12" Hxh Delantera	21-M521		
35,6cm	Mitsubishi Montero 14" Hxh Delantera	21-M522		
41cm	Mitsubishi Montero 16" Hxh Delantera	21-M523		
46cm	Mitsubishi Montero 18" Hxh Delantera	21-M524		
51cm	Mitsubishi Montero 20" Hxh Delantera	21-M525		

Codigo	21-M519			
				
Mitsubishi Montero 18" Mxh Delantera				
	Macho 10mm (paso 1.0) x 40mm	Long.	46cm	
	Hexagonal Fresada 10mm (paso 1.0) x 41.mm con Ombligo			

NISSAN

Manguera Embrague

Codigo	16-M501	39-20-01		
				
Nissan Embrague				
	Hembra Hexagonal 10mm (paso 1.0) x 35mm con Ombligo	Long.	36cm	
	Racord Ojo Fresado Ø10mm			

Codigo	39-20-02			
				
Nissan Junior 2000 Embrague				
	Macho M10x1	Long.	27,5cm	
	Hembra M10x1			

Codigo	39-20-03			
				
Nissan Mt 3000 Embrague				
	Hembra M10x1	Long.	33cm	
	Racord Ojo Ø10mm			

				
Hembra Hexagonal Fresado 10mm (paso 1.0) x 35.5mm con Ombligo Macho corto 10mm (paso 1.0) x 39mm				
Longitud	Descripción	Codigo		
30,5cm	Nissan Urban HXM 12" Embrague	16-M527		
40,7cm	Nissan Urban HXM 16" Embrague	16-M528		

NISSAN

Manguera Embrague

Codigo	16-M529	
		
Nissan Patfhinnder HXM Embrague		
Hembra 10mm (paso 1.0) x 44.5mm Con Ombliigo	Long.	38,5cm
Racord Ojo y Gancho Corto Ø10mm		

Codigo	16-M537	
		
Nissan D21 Tipo Furgon 2007... Embrague		
Hembra M10x1.0 Con Ombliigo	Long.	26cm
Macho M10x1.0		

		
Macho Universal 7/16" 20 NF x 41.mm Macho 5/8" 18 NF Hembra 3/8" 24 NF con Ombliigo		
Longitud	Descripcion	Codigo
34cm	Nissan 60/74 Delantera	16-M502 / 45-20-03
48cm	Nissan 60-74 M/Viejo Trasera	16-M503 / 45-20-04

		
Macho 10mm (paso 1.0) Hembra Hexagonal 10mm (paso 1.0) con Ombliigo		
Longitud	Descripcion	Codigo
32cm	Nissan 80/84 Trasera	16-M506 / 45-20-02
17,5cm	Nissan D21 Mod.1986 Delantera	16-M507 / 45-20-13

Manguera Freno

Codigo	16-M505	45-20-01
		
Nissan 80/84 Delantera		
Macho 10mm (paso 1.0) x 40mm	Long.	46cm
Hembra 10mm (paso 1.0) x 40mm con Ombliigo		

Codigo	45-20-40	
		
Nissan Cabstar 2900cc Mod 2003..Rueda Sencilla Delantera		
Hembra Rca.Int M10x1	Long.	62cm
Racord Panela Ojo Ø10mm		

Codigo	16-M526	45-20-07B
		
Nissan CabStar Trasera		
Racord Ojo Pasador Ø10mm	Long.	45,5cm
Racord Ojo Pasador Ø10mm		

Codigo	16-M531	45-20-39
		
Nissan Cabstar Mod. 2005-2008 Delantera		
Racord Ojo Ø10mm	Long.	39,5cm
Hembra 10mm (Paso 1.0) x 34mm Con Ombliigo		

Codigo	45-20-07C	
		
Nissan Cabstar Npu Trade 100 Trasera		
Macho M10x1	Long.	45cm
HembraM10x1		

Codigo	45-20-36	
		
Nissan Datsun 1500, 120 Y (HxH) Delantera		
Hembra M10x1	Long.	
Hembra M10x1		

NISSAN

Manguera Freno

Codigo	45-20-37	
		
Nissan Datsun 1500, 120 Y (HxM) Trasera		
Macho M10x1	Long.	32cm
Hembra M10x1		

Codigo	45-20-26	
		
Nissan Datsun 1,600 y 160 J Delantera		
Macho M10x1	Long.	34cm
Hembra M10x1		

Codigo	45-20-33	
		
Nissan D21 4x4 Trasera		
Hembra M10x1	Long.	45,5cm
Racord Panela Ojo Ø 8.5mm Rca. Int. M10x1		

Codigo	45-20-50	
		
Nissan Frontier Izq-Der Mod 2001-2004 Delantera		
Hembra M10x1	Long.	44cm
Racord Ojo Ø10mm		

		
Racord Ojo Espigo Largo Ø10mm Hembra 10mm (Paso 1.0) x 34mm Con Ombliigo		
Longitud	Descripcion	Codigo
45cm	Nissan Frontier 4x4 Derecha Delantera	16-M532 / 45-20-44
43,5cm	Nissan Frontier 4x4 Izquierda Delantera	45-20-45

Codigo	16-M535	45-20-51
		
Nissan Frontier Mod 98-10 Trasera		
Hembra 10mm (Paso 1.0) x 34mm Con Ombliigo	Long.	53,5cm
Racor Cuadrante Trooper		

		
Racord Ojo Ø10mm Der. Hembra 10mm (Paso 1.0) x 34mm Con Ombliigo		
Longitud	Descripcion	Codigo
39cm	Nissan Frontier 4x4 Derecha Delantera	16-M533 / 45-20-42
39cm	Nissan Frontier 4x4 Izquierda Delantera	16-M534 / 45-20-43

		
Racord Ojo Ø10mm Hembra 10mm (paso 1.0) sin Ombliigo		
Longitud	Descripcion	Codigo
59,5cm	Nissan Mt 3000/Nonplusultra Delantera	16-M509 / 45-20-07
67,5cm	Nissan Cabstar Mod 2003... (Izq-Der) Delantera	16-M509A / 45-20-07A

Codigo	45-20-49	
		
Nissan Mt 3000 mod 2004-2008 (Izq-Der) Delantera		
Hembra M10x1	Long.	65,5cm
Racord Ojo Ø10mm		

Codigo	16-M510	
		
Nissan Mt 3000/Nonplusultra Trasera		
Hembra Pin 12mm 10mm (paso 1.0) sin Ombliigo	Long.	56,5cm
Macho 10mm (paso 1.0)		

NISSAN

Manguera Freno

Codigo	45-20-53	
		
Nissan Navarra III D22 (Izq-Der) Mod 1988-2002 Trasera		
Hembra M10x1	Long.	48cm
Macho M10x1		

Codigo	16-M530	
		
Nissan Navarra Delantera		
Racord Ojo Ø10mm	Long.	39,5cm
Hembra 10mm (Paso 1.0) x 34mm Con Ombliigo		

		
Racord Panela Derecha Ø10mm Hembra Hexagonal 10mm (paso 1.0) x 35mm con Ombliigo		
Longitud	Descripcion	Codigo
41cm	Nissan Pick Up D.Cab.4X2 2000-2400 Der. Delantera	16-M512 / 45-20-10
40cm	Nissan Pick Up D. Cab. 4X2 2000-2400 Izq. Delantera	16-M513 / 45-20-11

		
Hembra M10x1 Racord Panela Ojo Ø10mm		
Longitud	Descripcion	Codigo
44cm	Nissan Pathfinder, D21 4x4 mod 93-98 Derecha Delantera	45-20-31
44cm	Nissan Pathfinder, D21 4x4 mod 93-98 Izquierda Delantera	45-20-32
46cm	Nissan Rh 4x4 Delantera	45-20-35

Codigo	45-20-12	
		
Nissan Pick Up Mod 70 Delantera		
Macho M10x1	Long.	40cm
Hembra M10x1		

Codigo	16-M511	
		
Nissan Patrol Mod.68. Delantera		
Hembra 3/8" 24 NF x 37mm Con Ombliigo	Long.	34cm
Macho Corto 3/8" 24 NF x 39mm		

Codigo	16-M515	
		
Nissan Pin Delantera		
Racord Ojo Pin Ø10mm	Long.	35cm
Hembra Hexagonal 10mm (paso 1.0) x 35mm con Ombliigo		

		
Hembra M10x1 Racord Ojo Ø10mm		
Longitud	Descripcion	Codigo
61,3cm	Nissan Qashqai Derecha Delantera	45-20-55
61,3cm	Nissan Qashqai Izquierda Delantera	45-20-56

Codigo	45-20-52	
		
Nissan Sentra (Izq-Der) Mod 2007-2013 Trasera		
Hembra M10x1	Long.	39cm
Hembra M10x1		

Codigo	45-20-54	
		
Nissan Sentra Mod 87-90 (Izq-Der) Delantera		
Hembra M10x1	Long.	52,1cm
Racord Ojo Ø10mm		

NISSAN

Manguera Freno

Codigo	45-20-09	
		
Nissan Sentra Todos Derecha Delantera		
Hembra M10x1	Long.	52cm
Racord Ojo Ø10mm		

Codigo	16-M516	45-20-08
		
Nissan Sentra B13 Izquierda Delantera		
Racord Ojo Largo Curvo Ø10mm	Long.	51cm
Hembra 10mm (Paso 1.0) x 34mm Con Ombliigo		

Codigo	45-20-34	
		
Nissan Sentra B12 Trasera		
Hembra M10x1	Long.	30cm
Hembra M10x1		

Codigo	16-M517	
		
Nissan Sentra Trasera		
Hembra 10mm (paso 1.0) x 35mm Hexagonal con Ombliigo	Long.	26,5cm
Hembra Hexagonal 10mm (paso 1.0) x 35mm con Ombliigo		

Codigo	16-M518	45-20-14
		
Nissan Sentra Pulsor Delantera		
Racord Ojo Largo Curvo Ø10mm	Long.	51cm
Hembra 10mm (Paso 1.0) x 34mm Con Ombliigo		

Codigo	16-M519	
		
Nissan Sunny/Pathfinder Delantera		
	Long.	

Codigo	45-20-48	
		
Nissan Tk 55 Mod 2013 Delantera		
Macho M10x1	Long.	74cm
Hembra M10x1		

Codigo	45-20-46	
		
Nissan UD-41 (Izq-Der) Delantera		
Hembra M10x1	Long.	51cm
Racord Ojo Ø10mm		

Codigo	16-M521	45-20-05
		
Nissan Urvan Delantera		
Hembra Hexagonal 10mm (paso 1.0) x 35mm con Ombliigo	Long.	38cm
Racord Ojo Pasador Ø10mm		

Codigo	16-M522	45-20-06
		
Nissan Urvan Trasera		
Hembra Hexagonal 10mm (paso 1.0) x 35mm con Ombliigo	Long.	34cm
Macho 10mm (paso 1.0) con Ombliigo		

NISSAN

Manguera Freno

Codigo	16-M525	45-20-47
		
Nissan Urvan MOD. 2005... Delantera		
Hembra 10mm (Paso 1.0) x 34mm Con Ombligo	Long.	51cm
Racord Ojo Pasador Ø10mm		

		
Racord Ojo Ø10mm		
Hembra 10mm (Paso 1.0) x 34mm Con Ombligo		
Longitud	Descripcion	Codigo
52cm	Nissan Urban 3.0 Derecha Delantera	16-M538
52cm	Nissan Urban 3.0 Izquierda Delantera	16-M539

Codigo	45-20-41	
		
Nissan Vanette (Izq-Der) 52 cms Delantera		
Hembra M10x1	Long.	51,5cm
Racord Ojo Ø10mm		

Codigo	45-20-38	
		
Nissan Y60 Motor 4.5 Delantera		
Hembra M10x1	Long.	39,5cm
Racord Ojo Pasador Ø10mm		

		
Macho M10x1		
Hembra M10x1		
Longitud	Descripcion	Codigo
21cm	Nissan 8 1/4" 46201-89908 Traseras	45-20-15
33,5cm	Nissan 13 1/4" 46201-89921 Traseras	45-20-16
35,6cm	Nissan 14" 42201-89922 Traseras	45-20-17
26cm	Nissan 10 1/4 46201-89911 Traseras	45-20-21
30cm	Nissan 11 3/4" 46201-89915 Traseras	45-20-22
46,4cm	Nissan 18 1/4" 46201-89946 Traseras	45-20-24

		
Macho M10x1		
Macho M10x1		
Longitud	Descripcion	Codigo
25,4cm	Nissan 10" Traseras	45-20-27
30,5cm	Nissan 12" Traseras	45-20-28
35,6cm	Nissan 14" Traseras	45-20-29
40,7cm	Nissan 16" Traseras	45-20-30

		
Hembra M10x1		
Hembra M10x1		
Longitud	Descripcion	Codigo
25,4cm	Nissan 10" 46204-89913 Traseras	45-20-18
34cm	Nissan 13 1/2" 46204-89921 Traseras	45-20-19
40,7cm	Nissan 16" 46214-89943 Traseras	45-20-20
30cm	Nissan 11 3/4" 46201-89918 Traseras	45-20-23

Bomba Vacio

Codigo	36A-20-01	
		
Manguera Nissan Mt 3000 Bomba Vacio		
Macho Rca. Ext 1/8"X18h	Long.	24,5cm
Racord Ojo Ø10mm		

PEUGEOT

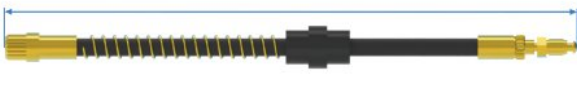
Codigo	45-35-01	
		
Kia Sportage Izquierda Delantera		
Hembra M10x1.0 Sin Ombligo	Long.	45,5cm
Macho M10x1.0		

Codigo	45-35-03	
		
Peugeot 306 (00-05) Trasera		
Hembra M10x1	Long.	22cm
Hembra M10x1		

Codigo	45-35-04	
		
Peugeot 306 (00-05) Trasera		
Hembra M10x1	Long.	29,2cm
Hembra M10x1		

RENAULT

Manguera Freno

		
Macho largo 3/8" 24 NF x 55mm Hembra Hexagonal Fresado 10mm (paso 1.0) x 35.5mm con Ombligo		
Longitud	Descripción	Codigo
52cm	Renault 4 Delantera	13-M501 / 45-21-01
42cm	Renault R-4/R-6 81-92 Delantera	13-M504
33cm	Renault 12 Delantera	13-M509
37cm	Renault 12/Dacia Larga Delantera	13-M510 / 45-21-07
33cm	Renault 12 Trasera	13-M511 / 45-21-08

		
Hembra Estriada 10mm (paso 1.0) x 37mm sin Ombligo Hembra Estriada 10mm (paso 1.0) x 37mm sin Ombligo		
Longitud	Descripción	Codigo
28cm	Renault 9 Estriada Trasera	13-M506 / 45-21-18
27,5cm	Renault 19 Trasera	13-M515 / 45-21-20
28cm	Renault Clio Trasera	13-M521 / 45-21-15
27cm	Renault Twingo Trasera	13-M524 / 45-21-17
34,5cm	Renault Logan Todos Trasera	13-M532 / 45-21-26

Codigo	13-M503	45-21-02
		
Renault 4/6 Hxh Derecha 42 cms Trasera		
Hembra 3/8" 24 NF x 37mm Con Ombligo	Long.	26cm
Hembra 3/8" 24 NF x 37mm Con Ombligo		

Codigo	13-M502	45-21-13
		
Renault 4/6 Mxh Izquierda Trasera		
Macho corto 3/8" 24 NF x 41mm	Long.	27,5cm
Hembra 3/8" 24 NF x 37mm Con Ombligo		

Codigo	13-M505	45-21-05
		
Renault 9 Estriada Delantera		
Macho 10mm (paso 1.0) x 40mm	Long.	40cm
Hembra Estriada 10mm (paso 1.0) x 37mm sin Ombligo		

Codigo	45-21-03	
		
Renault 6 81-92 48 cms Delantera		
Macho 3/8"x24H	Long.	48cm
Hembra 3/8"x24H		

RENAULT

Manguera Freno



Macho 10mm (paso 1.0) x 40mm
Hembra 10mm (paso 1.0) x 38.5mm sin Omblijo

Longitud	Descripcion	Codigo
39cm	Renault 9 Delantera	13-M507 / 45-21-04
30cm	Renault 18 Trasera	13-M513 / 45-21-10

Codigo	13-M508	45-21-06
Renault 9 Trasera		
Hembra 10mm (paso 1.0) x 38.5mm sin Omblijo	Long.	27,5cm
Hembra 10mm (paso 1.0) x 38.5mm sin Omblijo		

Codigo	13-M512	45-21-09
Renault 18 Delantera		
Macho 10mm (paso 1.0) x 40mm	Long.	40cm
Hembra 10mm (paso 1.0) x 38.5mm sin Omblijo		

Codigo	13-M530	45-21-24
Renault Clio II - Symbol / Citius Delantera		
Macho 10mm (paso 1.0) x 40mm	Long.	36,6cm
Hembra Estriada 10mm (paso 1.0) x 37mm sin Omblijo		

Codigo	45-21-29	
Renault Duster Trasera		
Hembra M10x1	Long.	31,4cm
Hembra M10x1		

Codigo	45-21-27	
Renault Kangoo (Izq-Der) Delantera		
Macho Renault 10mm (paso 1.0) x 40mm	Long.	
Hembra Hexagonal 10mm (paso 1.0) x 35mm con Omblijo		



Macho 10mm (paso 1.0) x 40mm
Hembra Estriada 10mm (paso 1.0) x 37mm sin Omblijo

Longitud	Descripcion	Codigo
49cm	Renault Laguna Delantera	13-M526 / 45-21-21
42cm	Renault Megane Delantera	13-M527 / 45-21-22



Macho 10mm (paso 1.0) x 40mm
Hembra Estriada 10mm (paso 1.0) x 37mm sin Omblijo

Longitud	Descripcion	Codigo
46cm	Renault Duster 4X4 Delantera	13-M533
47,5cm	Renault Duster 4X2 Delantera	13-M534 / 45-21-28



Macho 10mm (paso 1.0) x 40mm
Hembra Estriada 10mm (paso 1.0) x 37mm sin Omblijo

Longitud	Descripcion	Codigo
31,5cm	Renault 19 Delantera	13-M514 / 45-21-19
34cm	Renault 21 1600 Delantera	13-M516
27,5cm	Renault 21 1400 Corta Delantera	13-M517
40,5cm	Renault 21 Rx/1600 Larga Delantera	13-M518 / 45-21-11
27,5cm	Renault Clio Delantera	13-M520 / 45-21-14
58cm	Renault Laguna Delantera	13-M522
27,5cm	Renault Twingo Delantera	13-M523 / 45-21-16
34cm	Renault Logan Todos Delantera	13-M531 / 45-21-28
30cm	Renault Megane Trasera	13-M535 / 45-21-23

SIMCA

Manguera Freno

Codigo	33-M501	
		
Simca 1300 Del-Tra		
Hembra 3/8" 24 NF x 37mm Con Ombligo		Long. 36cm
Macho Corto 3/8" 24 NF x 39mm		

SUBARU

Manguera Freno

Codigo	42-201	
		
Subaru 84-86 Delantera		
Hembra Hexagonal Fresada 10mm (paso 1.0) x 41mm con Ombligo		Long. 51,5cm
Racord Ojo Corto Ø10mm		

Codigo	42-203	
Subaru 84-86 Trasera		
		Long.

SUZUKI

Manguera Freno

Codigo	32-M503	45-23-02
		
Suzuki Sj410 (Corta) Freno Disco Delantera		
Racord Ojo Largo Curvo Ø10mm		Long. 30cm
Macho 16mm (paso 1.5) - Hembra 10mm (paso1.0)		

Codigo	45-23-03	
		
Suzuki Sj-410 Rosca Externa Delantera		
Hmb.Rca.Ext.M16x1.5 Rca.Int.M10x1		Long. 33cm
Hmb.Rca.Ext.M16x1.5 Rca.Int.M10x1		

Codigo	45-23-04	
		
Suzuki Sj-413 Delantera		
Macho Rca.Ext. M10x1		Long. 31cm
Racord Ojo Ø10mm		

Codigo	32-M504	
		
Suzuki Lj80 Delantera		
Macho 16mm (paso 1.5) - Hembra 10mm (paso1.0)		Long. 35,5cm
Macho 16mm (paso 1.5) - Hembra 10mm (paso1.0)		

Codigo	32-M505	45-23-01
		
Suzuki Sj410 Delantera		
Racord Ojo Largo Ø10mm		Long. 28cm
Hembra 10mm (Paso 1.0) x 34mm Con Ombligo		

Codigo	32-M506	
		
Suzuki Sj410 Trasera		
Hembra 10mm (Paso 1.0) x 34mm Con Ombligo		Long. 40,5cm
Hembra 10mm (Paso 1.0) x 34mm Con Ombligo		

TOYOTA

Manguera Embrague

Codigo	17-M503	
Toyota 80... Embrague		
Macho corto 10mm (paso 1.0) x 39mm	Long.	30cm
Hembra Hexagonal 10mm (paso 1.0) con Ombligo		

Codigo	17-M504	
Toyota Land Cruiser central ...84 Embrague		
Macho 10mm (paso 1.0) x 40mm	Long.	36cm
Hembra Hexagonal 10mm (paso 1.0) con Ombligo		

Macho 10mm (paso 1.0) x 40mm Hembra Estriada 10mm (paso 1.0) x 37mm sin Ombligo		
Longitud	Descripcion	Codigo
26,5cm	Manguera Embrague Toyota Hilux 4x2/4x4 Embrague	17-M501 / 39-24-01
26,5cm	Toyota Hilux 4X2 4X4 Embrague	17-M502

Manguera Freno

Codigo	45-24-12	
Toyota 4x4 (HxM) Delantera		
Hembra 10mm (paso 1.0) x 44.5mm Con Ombligo	Long.	46cm
Macho Renault - 10mm (paso 1.0) x 40mm		

Codigo	45-24-13	
Toyota 4x4 (HxH) Trasera		
Hembra M10x1	Long.	46cm
Hembra M10x1		

Codigo	17-M505	
Toyota 4.5 93... Hxm Trasera		
Macho 10mm (paso 1.0) x 40mm	Long.	47cm
Hembra con Ombligo 10mm (paso 1.0) x 40mm		

Codigo	17-M506	
Toyota 4.5 93... Mxm Int. Freno		
Macho 10mm (paso 1.0)	Long.	19cm
Macho 10mm (paso 1.0)		

Codigo	17-M507	
Toyota 4.5 93... Gancho Delantera		
Hembra 10mm (paso 1.0) x 44.5mm Con Ombligo	Long.	31,5cm
Racord Ojo y Gancho Corto Ø10mm		

Hembra 10mm (paso 1.0) x 40mm con Ombligo Racord Pin Ojo Ø10mm		
Longitud	Descripcion	Codigo
35cm	Toyota Burbuja Derecha Delantera	17-M508 / 45-24-07
35cm	Toyota Burbuja Izquierda Delantera	17-M509 / 45-24-08

TOYOTA

Manguera Freno

Codigo	17-M532	
		
Toyota Burbuja Trasera		
Hembra 10mm (paso 1.0) x 40mm con Ombligo	Long.	27,5cm
Racord Pin Ojo Ø10mm		

Codigo	45-24-30	
		
Toyota Campero-Camioneta Mod 85-93 Delantera		
Hembra 10mm (paso 1.0) x 44.5mm Con Ombligo	Long.	19cm
Macho Renault - 10mm (paso 1.0) x 40mm		

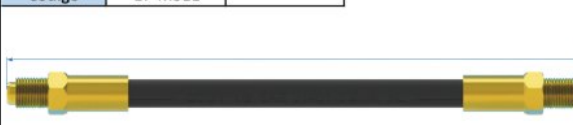
Codigo	17-M511	
		
Toyota Celica 76/81 Delantera		
Macho 10mm (paso 1.0) x 40mm	Long.	20,5cm
Macho 10mm (paso 1.0) x 40mm		

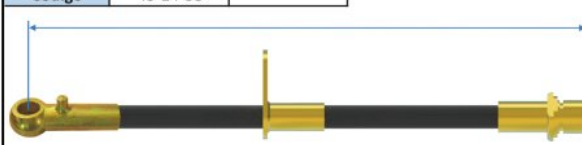
Codigo	45-24-38	
		
Toyota Coaster Mod 98-98 (Izq-Der) Delantera		
Hembra Fresado 10mm (paso 1.0) con Ombligo	Long.	51,5cm
Racord Ojo con Pin		

Codigo	45-24-43	
		
Toyota Coaster (Izq-Der) Delantera		
Hembra M10x1	Long.	79cm
Racord Ojo Ø10mm		

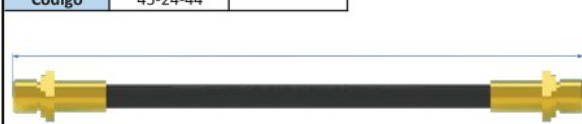
Codigo	45-24-44	
		
Toyota Coaster 33 cms Delantera		
Hembra M10x1	Long.	33cm
Hembra M10x1		

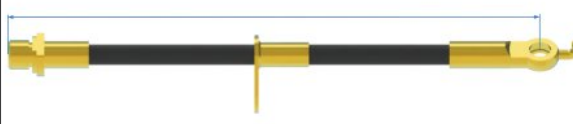
		
Hembra 10mm (paso 1.0) x 40mm con Ombligo Racord Pin Ojo Ø10mm		
Longitud	Descripcion	Codigo
63,5cm	Toyota Corolla Mod 2008-2019 Izquierda Delantera	45-24-55
63,5cm	Toyota Corolla Mod 2008-2019 Derecha Delantera	45-24-56

		
Macho 10mm (paso 1.0) Hembra Hexagonal 10mm (paso 1.0) con Ombligo		
Longitud	Descripcion	Codigo
24cm	Toyota Corta 78/84 Delantera	17-M514 / 45-24-01
19cm	Toyota Corta 84... Delantera	17-M515

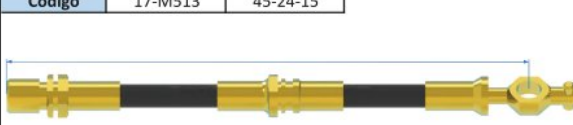
Codigo	17-M513	45-24-15
		
Toyota Corolla Mod 87 Delantera		
Racord Pin Ojo Ø10mm		
Hembra Hexagonal Fresada 2 Caras 10mm (paso 1.0) con Ombligo	Long.	50cm

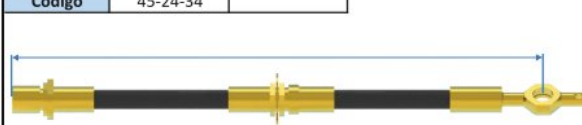
Codigo	45-24-34	
		
Toyota Corolla Trasera		
Hembra. M10x1		
Racord Ojo Ø10mm	Long.	50cm

TOYOTA

Manguera Freno

Codigo	45-24-57	
		
Toyota Dina (01-07) Dina 150 02-04, Dina 350 09 Trasera		
Hembra M10x1	Long.	41cm
Macho M10x1		

Codigo	45-24-39	
		
Toyota Dina Mod 95-99 Delantera		
Macho 10mm (paso 1.0)	Long.	39cm
Hembra Hexagonal 10mm (paso 1.0) con Omblogo		

Codigo	45-24-40	
		
Toyota Hiace Izq-Der Delantera		
Hembra M10x1	Long.	32cm
Hembra M10x1		

		
Macho 10mm (paso 1.0) Hembra Hexagonal 10mm (paso 1.0) con Omblogo		
Longitud	Descripcion	Codigo
36cm	Toyota Hiace Mod 2007-2012 Izquierda Delantera	45-24-41
36cm	Toyota Hiace Mod 2007-2012 Derecha Delantera	45-24-42

Codigo	45-24-31	
		
Toyota Hiace Mod 82... Delantera		
Hembra M10x1	Long.	40cm
Racord Ojo Ø10mm		

Codigo	45-24-32	
		
Toyota Hiace Mod 82... Trasera		
Macho M10x1	Long.	35cm
Hembra M10x1		

Codigo	45-24-58	
		
Toyota Hilux (98-06) Camry (Izq-Der) Delantera		
Hembra M10x1	Long.	36cm
Hembra M10x1		

Codigo	45-24-28	
		
Toyota Hilux 4x4 Mod 84-89 Izquierda (HxM) Delantera		
Macho M10x1	Long.	53,5cm
Hembra M10x1		

		
Hembra Hexagonal 10mm (paso 1.0) con Omblogo Hembra Hexagonal 10mm (paso 1.0) con Omblogo		
Longitud	Descripcion	Codigo
30,5cm	Toyota Corolla Mod 72 Delantera	17-M512 / 45-24-14
36,5cm	Toyota Hilux 4X4 Delantera	17-M516 / 45-24-10
49,5cm	Toyota Land Cruiser Trasera	17-M522
34cm	Toyota Land Cruiser 85... Central Delantera	17-M524
36cm	Toyota Vigo Delantera	17-M531

		
Macho corto 10mm (paso 1.0) x 39mm Hembra Hexagonal 10mm (paso 1.0) con Omblogo		
Longitud	Descripcion	Codigo
45cm	Toyota Land Cruiser Delantera	17-M521
44,5cm	Toyota Larga 70/74 Trasera	17-M525 / 45-24-02
30,5cm	Toyota 4.5 Hxm Corta Delantera	17-M529 / 45-24-06

TOYOTA

Manguera Freno

Codigo	17-M518	
		
Toyota Hilux 4X2 Delantera		
Hembra Hexagonal Fresada 2 Caras 10mm (paso 1.0) con Ombligo	Long.	35cm
Hembra Hexagonal Fresada 2 Caras 10mm (paso 1.0) con Ombligo		

Codigo	45-24-45	
		
Toyota Hilux - Tacoma (Izq-Der) Mod 98-2005 Trasera		
Macho M10x1	Long.	42cm
Hembra M10x1		

		
Macho 10mm (paso 1.0) x 40mm Hembra Hexagonal 10mm (paso 1.0) con Ombligo		
Longitud	Descripcion	Codigo
41cm	Toyota Hilux 4X4 Trasera	17-M517 / 45-24-11
43cm	Toyota Hilux 4X2 Trasera	17-M519
27cm	Toyota Land Cruiser ...84 Central Delantera	17-M523

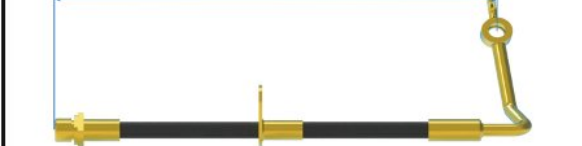
		
Hembra M10x1 Racord Ojo Ø10mm		
Longitud	Descripcion	Codigo
43cm	Toyota Hilux Izquierda Mod 2015 Delantera	45-24-46
43cm	Toyota Hilux Derecha Mod 2015 Delantera	45-24-47

Codigo	45-24-48	
		
Toyota Hilux Tacoma (Izq-Der) 95-2004 Delantera		
Macho M10x1	Long.	44cm
Hembra M10x1		

Codigo	45-24-04	
		
Toyota Modelo Viejo 51 cms Delantera		
Macho Rca.Ext 7/16"x20H	Long.	51cm
Hembra 9x1		

Codigo	45-24-37	
		
Toyota Rav 4 Delantera		
Hembra M10x1 Racord Ojo Ø10mm	Long.	51cm

Codigo	45-24-49	
		
Toyota Tacoma Derecha 95-2004 Delantera		
Racord Ojo Ø10mm Hembra M10x1	Long.	56,5cm

		
Hembra M10x1 Hembra M10x1		
Longitud	Descripcion	Codigo
49cm	Toyota Tacoma V6 4.0 L Izquierda Mod 2005/11 Trasera	45-24-50
50,5cm	Toyota Tacoma V6 4.0 L Derecha Mod 2005/11 Trasera	45-24-51

		
Hembra M10x1 Racord Ojo Ø10mm		
Longitud	Descripcion	Codigo
55cm	Toyota Tacoma Derecha 95-2004 Delantera	45-24-52
55cm	Toyota Tacoma Izquierda 95-2004 Delantera	45-24-53

TOYOTA

Manguera Freno

Codigo	45-24-54	
Toyota Tacoma Runner Central Mod 2000-2004 Traseras		
Hembra M10x1	Long.	44,3cm
Macho M10x1		

Codigo	45-24-33	
Toyota Tercel Traseras		
Hembra M10x1	Long.	28,5cm
Hembra M10x1		

Codigo	17-M527	45-24-29
Toyota Tercer Der-Izq Delantera		
Hembra 10mm (paso 1.0) x 42.5mm sin Omblijo	Long.	47cm
Hembra Fresado 10mm (paso 1.0) con Omblijo		

Codigo	17-M530	
Toyota Vigo 2007 Der / Izq Delantera		
Ø10mm Ojo y Gancho Corto	Long.	43,5cm
Hembra 10mm (Paso 1.0) x 34mm Con Omblijo		

Codigo	17-M528	
Toyota Vigo Traseras		
Hembra 10mm (Paso 1.0) x 34mm Con Omblijo	Long.	40cm
Hembra 10mm (Paso 1.0) x 34mm Con Omblijo		

Hembra M10x1 Racord Ojo Ø10mm		
Longitud	Descripcion	Codigo
35cm	Toyota Yaris Todos Derecha Delantera	45-24-35
36,5cm	Toyota Yaris Todos Izquierda Delantera	45-24-36

Macho M10x1 Hembra M10x1		
Longitud	Descripcion	Codigo
34,5cm	Toyota 13" 1/2" 96910-33805 Traseras	45-24-16
16cm	Toyota 6 1/4" 96940-39855 Traseras	45-24-18
45,5cm	Toyota 17 1/2" 96910-34805 Traseras	45-24-19
20cm	Toyota 8" 96960-32405 Traseras	45-24-22
39cm	Toyota 15 1/2" 90947-02244 Traseras	45-24-23

Macho M10x1 Macho M10x1		
Longitud	Descripcion	Codigo
25,4cm	Toyota 10" Traseras	45-24-24
30,5cm	Toyota 12" Traseras	45-24-25
35,6cm	Toyota 14" Traseras	45-24-26
40,7cm	Toyota 16" Traseras	45-24-27

Hembra M10x1 Hembra M10x1		
Longitud	Descripcion	Codigo
45,5cm	Toyota 14" 96950-33505 Traseras	45-24-17
29cm	Toyota 11 1/2" 90947-02393 Traseras	45-24-20

TOYOTA

Bomba Vacía - Aceite

Codigo	36A-24-01	
		
Toyota Hilux Hiace Bomba Aceite		
Racord Ojo Ø10mm	Long.	13cm
Racord Ojo Ø10mm		

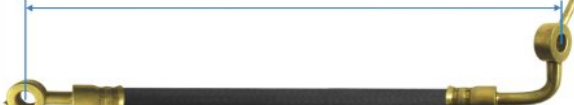
Codigo	36A-24-02	
		
Toyota Hilux Vigo Land Cruiser- Mod 2002-2012 Bomba Vacío		
Racord Ojo Ø10mm	Long.	39cm
Racord Ojo Ø10mm		

Codigo	36A-24-03	
		
Toyota Hilux Hiace 82-2006 Manguera Alternador Alternador		
Racord Ojo Ø10mm	Long.	25,5cm
Racord Ojo Ø10mm		

Codigo	36A-24-04	
		
Toyota Hilux Vigo y Otros Bomba Vacío		
Racord Ojo Ø10mm	Long.	41,5cm
Racord Ojo Ø10mm		

UNIVERSAL

Freno Aire 1/4"

		
Macho 1/4"x18H Hembra 3/4"X16H		
Longitud	Descripcion	Codigo
46cm	Manguera Freno Aire Universal 18"	24-M501
51cm	Manguera Freno Aire Universal 20"	24-M502
56cm	Manguera Freno Aire Universal 22"	24-M503 / 44-08-01
61cm	Manguera Freno Aire Universal 24"	24-M504 / 44-08-02
66cm	Manguera Freno Aire Universal 26"	24-M505 / 44-08-03
71cm	Manguera Freno Aire Universal 28"	24-M506 / 44-08-04
76cm	Manguera Freno Aire Universal 30"	24-M507 / 44-08-05
81cm	Manguera Freno Aire Universal 32"	24-M508 / 44-08-06
86cm	Manguera Freno Aire Universal 34"	24-M509 / 44-08-07
91cm	Manguera Freno Aire Universal 36"	24-M510 / 44-08-08
97cm	Manguera Freno Aire Universal 38"	24-M511 / 44-08-09
102cm	Manguera Freno Aire Universal 40"	24-M512 / 44-08-10
107cm	Manguera Freno Aire Universal 42"	24-M513 / 44-08-11
112cm	Manguera Freno Aire Universal 44"	24-M514 / 44-08-12
117cm	Manguera Freno Aire Universal 46"	24-M515 / 44-08-13
122cm	Manguera Freno Aire Universal 48"	24-M516 / 44-08-14
127cm	Manguera Freno Aire Universal 50"	24-M517 / 44-08-15

		
Macho 1/4"x18H Hembra 3/4"X16H		
Longitud	Descripcion	Codigo
56cm	Freno Aire Universal 22" (Tipo Ford)	44-08-16
61cm	Freno Aire Universal 24" (Tipo Ford)	44-08-17
66cm	Freno Aire Universal 26" (Tipo Ford)	44-08-18
76cm	Freno Aire Universal 30" (Tipo Ford)	44-08-20
81cm	Freno Aire Universal 32" (Tipo Ford)	44-08-21
86cm	Freno Aire Universal 34" (Tipo Ford)	44-08-22
91cm	Freno Aire Universal 36" (Tipo Ford)	44-08-23
96,5cm	Freno Aire Universal 38" (Tipo Ford)	44-08-24
101cm	Freno Aire Universal 40" (Tipo Ford)	44-08-25
107cm	Freno Aire Universal 42" (Tipo Ford)	44-08-26
117cm	Freno Aire Universal 46" (Tipo Ford)	44-08-28
127cm	Freno Aire Universal 50" (Tipo Ford)	44-08-30

Freno Aire 1/4"

Codigo	44-10-01	
		
Manguera Freno Aire Agrale Delantera Mod 2009 Freno Aire		
Racord Ojo Ø15mm	Long.	73,5cm
Hembra M18x2		

UNIVERSAL

Freno Liquido



Macho Universal 7/16" 20 NF x 41.mm
Macho Corto 3/8" 24 NF x 39mm

Longitud	Descripcion	Codigo
41cm	Manguera Freno Liquido 16" M 3/16 X M1/4	24-M524
46cm	Manguera Freno Liquido 18" M 3/16 X M1/4	24-M529



Macho Universal 7/16" 20 NF x 41.mm
Hembra Hexagonal 3/8" 24 NF x 41mm con Ombligo

Longitud	Descripcion	Codigo
41cm	Manguera Freno Liquido 16" (H=3/16Xm=1/4)	24-M527
46cm	Manguera Freno Liquido 18" (H=3/16Xm=1/4)	24-M532

Codigo 24-M526



Manguera Freno Liquido 16" (H=1/4Xm=3/16)

Long.	Codigo
41cm	24-M526

Codigo 24-M531

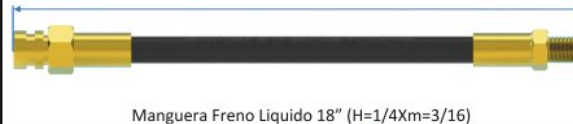

Manguera Freno Liquido 18" (H=1/4Xm=3/16)

Long.	Codigo
46cm	24-M531



Macho Universal 7/16" 20 NF x 41.mm
Macho 3/8" 24 NF Con Ombligo

Longitud	Descripcion	Codigo
51cm	Manguera Freno Liquido 20" M 3/16 X M1/4	24-M533
56cm	Manguera Freno Liquido 22" M 3/16 X M1/4	24-M539

Codigo 24-M535



Manguera Freno Liquido 20" (H=1/4Xm=1/4)

Long.	Codigo
51cm	24-M535

Codigo 24-M546

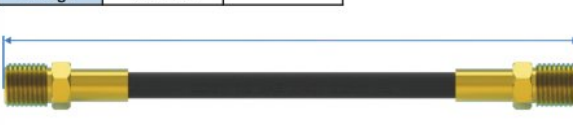

Manguera Hembramacho 7/16X5/8 De 40 Cm

Long.	Codigo
40cm	24-M546



Hembra M11x1.0 Con Ombligo
Macho M11x1.25

Longitud	Descripcion	Codigo
30cm	Manguera Freno Copa Int.1/4" Macho 7/16" Freno Liquido	45-00-01
50cm	Manguera Freno Copa Int.1/4" Macho 7/16" Freno Liquido	45-00-02
60cm	Manguera Freno Copa Int.1/4" Macho 7/16" Freno Liquido	45-00-03



Macho 7/16"
Hembra 3/16"

Longitud	Descripcion	Codigo
30cm	Manguera Freno Copa Int.3/16" Macho 7/16" Freno Liquido	45-00-04
50cm	Manguera Freno Copa Int.3/16" Macho 7/16" Freno Liquido	45-00-05

Codigo 45-00-06





Manguera Freno Liquido 1/4" X 7/16" Freno Liquido

Long.	Codigo
40cm	45-00-06

UNIVERSAL

Freno Liquido

Codigo	45-00-07	
		
Manguera Freno Liquido 7/16" X 3/16" Freno Liquido		
Macho 7/16"	Long.	40cm
Hembra 3/16"		

Codigo	45-00-08	
		
Manguera Copa 3/16 Macho 3/8" 18" Freno Liquido		
Macho Ext. 3/16"	Long.	46cm
Copa Int. 3/8"		

Codigo	45-00-09	
		
Manguera Freno 1/4X1/4 HXH 19" L Freno Liquido		
Hembra 7/16" X 24 h	Long.	48cm
Hembra 7/16" X 24 h		

Codigo	45-00-12	
		
Manguera Freno 3/16 Macho X 1/4" H 14" Freno Liquido		
Macho Ext. 3/16"	Long.	37cm
Copa Int. 1/4"		

Codigo	53-00-04	
		
Pin Sujetador Universal Para Mang. Freno Liquido (Pequeño)		

Manguera Engrasadora

		
Macho Engrasadora 1/8" NPT		
Hembra Hexagonal Fresado 10mm (paso 1.0) x 35.5mm con Ombligo		
Longitud	Descripcion	Codigo
25cm	Manguera Para Engrasadora	24-M562 / 43-00-01
33cm	Manguera Para Engrasadora	24-M563 / 43-00-02
40,5cm	Manguera Para Engrasadora	24-M564 / 43-00-03
50cm	Manguera Para Engrasadora	24-M565 / 43-00-04
90cm	Manguera Para Engrasadora	24-M566 / 43-00-06

VOLKSWAGEN

Manguera Freno

Codigo	45-26-10	
		
Volkswagen Amarok Mod Nuevo Delantera		
Macho M10x1	Long.	58,5cm
Hembra M10x1		

Codigo	30-M501	
		
Volkswagen Escarabajo 67-78 Delantera		
Macho 10mm (paso 1.0) x 40mm	Long.	48,5cm
Hembra 10mm (paso 1.0) Pin 12mm sin Ombligo		

VOLKSWAGEN

Manguera Freno

Codigo	30-M504	
Volkswagen Escarabajo 68-70 / 76-78 Trasera		
Macho 10mm (paso 1.0) x 40mm	Long.	25cm
Hembra 10mm (paso 1.0) sin Ombligo		

Codigo	30-M509	45-26-11
Volkswagen Golf / Vento Mod. 1992 Trasera		
Macho M10 x 1.0	Long.	49,5cm
Hembra 10mm (paso 1.0) sin Ombligo		

Codigo	30-M511	45-26-12
Volkswagen Golf 94/.... Delantera		
Macho 10mm (paso 1.0) x 40mm	Long.	35cm
Hembra 10mm (paso 1.0) sin Ombligo		

Codigo	30-M510	
Volkswagen LT II 28-46 (Mercedes Sprinter all) Del-Tra		
Macho M10 x 1.0	Long.	35cm
Hembra 10mm (paso 1.0) sin Ombligo		

Codigo	30-M506	
Volkswagen Super Escarabajo 71-78 Delantera		
Hembra 10mm (paso 1.0) sin Ombligo	Long.	34cm
Hembra 10mm (paso 1.0) sin Ombligo		

VARIOS

Mangueras Infallantas

Longitud	Descripcion	Codigo
8m	Manguera Infallantas 8 Metros Infallantas	47-00-01e / 47-00-01
10m	Manguera Infallantas 10 Metros	47-00-02e / 47-00-02
12m	Manguera Infallantas 12 Metros	47-00-03e / 47-00-03
15m	Manguera Infallantas 15 Metros	47-00-04e / 47-00-04

WILLYS

Manguera Freno

Hembra 3/8"x24H		
Hembra 3/8"x24H		
Longitud	Descripcion	Codigo
18cm	Willys Mod Viejo 7" Especial Trasera	45-27-01
28cm	Willys Mod 62-69 / 71-73 Delantera	45-27-04

Macho 3/8"x24H		
Hembra Hexagonal Fresado 10mm (paso 1.0) x 35.5mm con Ombligo		
Longitud	Descripcion	Codigo
21cm	Willys 12" Delantera	45-27-07
26cm	Willys 14" (HxM) Delantera	45-27-10
30cm	Willys Cdj Mod 61-76 16" Trasera	45-27-11
33,5cm	Willys 18" Larga Delantera	45-27-12
35,6cm	Willys 21" Delantera	45-27-13

GARANTÍA DE FÁBRICA

La garantía es procedente para las líneas de autopartes ASAM SAS cuando el producto o la pieza presenta fallas o alteraciones de sus funciones provocadas SOLAMENTE por defecto del material o de fabricación, dentro de los 2 meses siguientes a partir de la fecha de facturación y comprende el cambio del repuesto.

ASAM SAS no se hace responsable por garantías si el producto:

- * Está fuera de los plazos de garantía
- * Ha sido almacenado inadecuadamente.
- * Ha sido utilizado indebidamente (instalación incorrecta, mal uso).
- * Se ha utilizado para aplicaciones fuera de las especificaciones (adaptaciones).
- * Problemas externos.



“Las grandes cosas en los negocios
nunca son realizadas por una persona.
Son hechas por un equipo”

- Steve Jobs



CONTÁCTANOS:

Móvil: (57) 310 814 8858

(57) 310 875 4183

Email: comercial@asam.com.co

www.asam.com.co

