

En **AUTOPARTES**  
nuestro respaldo,  
su tranquilidad.



[www.asam.com.co](http://www.asam.com.co)



En **AUTOPARTES**  
nuestro respaldo, su tranquilidad.

# CATÁLOGO DE PRODUCTOS

**CESAR  
FAJARDO**

CEL: 310 814 8858  
TEL: 742 5422 EXT. 102  
@comercial@asam.com.co

**FREDDY  
MONTEALEGRE**

CEL: 310 850 7384  
@comercial3@asam.com.co

**JUAN DIEGO  
GONZALEZ**

CEL: 310 858 6257  
@comercial1@asam.com.co

Trv. 42 (AV. Ferrocarril) No. 9 - 70 - PBX: (57 - 1) 7425422  
gerencia@asam.com.co - www.asam.com.co - Bogotá - Colombia

asam  
S.A.S.

En **AUTOPARTES**  
nuestro respaldo,  
su tranquilidad.





“Las grandes cosas en los negocios  
nunca son realizadas por una persona.  
Son hechas por un equipo”

- Steve Jobs

# INDICE DE PRODUCTOS

## CARROCERIA

ABRAZADERAS Y ARANDELAS	Pag. 7
TUERCAS	Pag. 12
CHAPAS Y BISAGRAS	Pag. 13
GANCHOS DE CAPOT	Pag. 14
SELLOS DE BLOQUE	Pag. 15
HORQUILLAS	Pag. 16
SOPORTE MOTOR	Pag. 16
PERNOS	Pag. 16
TAPONES DECARTER	Pag. 16
TORNILLOS VARIOS	Pag. 17
QUEMADORES	Pag. 17

## SISTEMA DE FRENOS

GRADUACIONES	Pag. 18
PIVOTES	Pag. 22
PUNTILLAS PARA FRENO	Pag. 22
TORNILLOS PARA FRENOS	Pag. 22
SEPARADORES DE CARRETA	Pag. 23

## SUSPENSIÓN

BALANCINES Y BUJES	Pag. 23
PASADORES HOJA DE RESORTE	Pag. 28
PASADORES DE TIJERA	Pag. 30
PASADORES DE MUELLE	Pag. 32
RODAMIENTOS	Pag. 33
SOPORTES DE CARDAN	Pag. 34
TORNILLO BARRA ESTABILIZADORA	Pag. 40
TORNILLOS DE TORSIÓN	Pag. 41
VARILLA ESTABILIZADORA	Pag. 43

## COMPLEMENTARIOS

ZAPAS	Pag. 49
BORNES PARA BATERIA	Pag. 49
CONOS DE EJE	Pag. 49
GRAPAS CRUCETA	Pag. 49
PINES	Pag. 49

## ABRAZADERAS DE EXOSTO / MUFFLER



COD.	REF.	UN. EMP.	DESCRIPCION	∅	↕	↔
02-00-01	A-35A	10	ABRAZADERA DE EXOSTO 1 1/8"	1 1/8"	70 mm	54 mm
02-00-02	A-36A	10	ABRAZADERA DE EXOSTO 1 1/4"	1 1/4"	75 mm	57 mm
02-00-03	A-36	10	ABRAZADERA DE EXOSTO 1 1/2"	1 1/2"	83 mm	67.5 mm
02-00-04	A-37	10	ABRAZADERA DE EXOSTO 1 5/8"	1 5/8"	80 mm	77 mm
02-00-05	A-38	10	ABRAZADERA DE EXOSTO 1 3/4"	1 3/4"	85 mm	79 mm
02-00-06	A-39	10	ABRAZADERA DE EXOSTO 1 7/8"	1 7/8"	93 mm	82 mm
02-00-07	A-40	10	ABRAZADERA DE EXOSTO 2"	2"	100 mm	85.5 mm
02-00-08	A-41	10	ABRAZADERA DE EXOSTO 2 1/4"	2 1/4"	120 mm	91 mm
02-00-09	A-42	10	ABRAZADERA DE EXOSTO 2 1/2"	2 1/2"	112 mm	96 mm
02-00-10	A-43	10	ABRAZADERA DE EXOSTO 2 3/4"	2 3/4"	120 mm	100 mm
02-00-11	A-44	10	ABRAZADERA DE EXOSTO 3"	3"	133 mm	106 mm
02-00-12	A-50A	5	ABRAZADERA DE EXOSTO 3 1/2" - Reforzada	3 1/2"	145 mm	130 mm
02-00-13	A-50B	5	ABRAZADERA DE EXOSTO 4" - Reforzada	4"	150 mm	146 mm
02-00-15	A-50	5	ABRAZADERA DE EXOSTO 4 1/2" - Reforzada	4 1/2"	180 mm	155 mm
02-00-17	A-50D	5	ABRAZADERA DE EXOSTO 5" - Reforzada	5"	180mm	164 mm
02-00-20		2	ABRAZADERA DE EXOSTO 5 1/2" - Reforzada	5 1/2"	19.5 mm	178 mm

## ARANDELAS

<p>COD. 04-00-02</p> <p>UN. EMP. 100</p> <p>ARANDELA AMORTIGUADOR 3/8" - AA</p> <p>∅ Int. 10.8 mm    ∅ Ext. 36mm    ↕ 2 mm</p>	<p>COD. 04-00-01</p> <p>UN. EMP. 100</p> <p>ARANDELA AMORTIGUADOR 1/2"</p> <p>∅ Int.12.8 mm    ∅ Ext. 42.2mm    ↕ 1 mm</p>	<p>COD. 08-01-01</p> <p>UN. EMP. 10</p> <p>ARANDELA PINADORA CARPATI GAZ</p> <p>∅ Int. 45.7mm    ∅ Ext. 68 mm    ↕ 1.2mm</p>
--	--	--

	UN. EMP. 10	COD.	DESCRIPCION	∅ Int.	∅ Ext.	↕
		08-03-01	ARANDELA PINADORA PEQUEÑA CHEVROLET	52 mm	60 mm	1 mm
		08-03-02	ARANDELA PINADORA MEDIANA CHEVROLET	54 mm	65 mm	1 mm
		08-03-03	ARANDELA PINADORA GRANDE CHEVROLET		0	0



**CHEVROLET**

<b>COD. 08-03-04</b>  <b>ARANDELA PINADORA LUV</b> ∅ Int. 34.4 mm    ∅ Ext. 60.4 mm    ⇅ 1.2 mm	<b>COD. 08-03-05</b> OEM 9-09853-026-0  <b>ARANDELA PINADORA TRASERA LUV/ISUZU</b> ∅ Int. 40mm    ∅ Ext. 72.8mm    ⇅ 1.3 mm	<b>COD. 05-03-05</b>  <b>ARANDELA CACHO NPR</b> ∅ Int. 28 mm    ∅ Ext. 54.5    ⇅ 4.4 mm
---	--	---

**DAHIATSU**



	UN. EMP. 10	COD.	DESCRIPCION	∅ Int.	∅ Ext.	⇅
		08-05-01	ARANDELA PINADORA F10 - 20 DELANTERA	64 mm	97 mm	1.9 mm
		08-05-02	ARANDELA PINADORA F10 - 20 TRASERA	36 mm	49 mm	1 mm
		08-05-03	ARANDELA CENTRAL DAHIATSU F20	22.5 mm	58 mm	2.5 mm
		08-08-04	ARANDELA PINADORA HAUSSING DELTA	26.5 mm	63.5 mm	2.5 mm

**DODGE 100-300**

<b>COD. 05-06-01</b>  <b>ARANDELA CACHO D100 / DODGE DART</b> ∅ Int. 21 mm    ∅ Ext. 37 mm    ↔ 2 mm	<b>COD. 05-06-02</b>  <b>ARANDELA CACHO D300 - ACD300</b> ∅ Int. 21 mm    ∅ Ext. 39mm    ↔ 2mm
--	--

	UN. EMP. 20	COD.	DESCRIPCION	∅ Int.	∅ Ext.	⇅
		08-06-01	ARANDELA PINADORA HAUSSING D300	21 mm	37 mm	2 mm
		08-06-02	ARANDELA PINADORA HAUSSING D600	64.4 mm	96 mm	2 mm
		08-06-03	ARANDELA PINADORA DODGE D500 Y Busetas	64.5 mm	96 mm	2 mm

	UN. EMP. 10	COD.	DESCRIPCION	∅ Int.	∅ Ext.	⇅
		11-06-01	ARANDELA PINADORA D100 / TOYOTA HILUX	19 mm	34 mm	8.5 mm
		11-06-02	ARANDELA PINADORA D300	21 mm	40 mm	9,8 mm
		11-06-03	ARANDELA PINADORA D600 - Grande	24 mm	46 mm	12.2 mm

<b>COD. 08-05-01</b>  <b>ARANDELA CACHO AUTO CAMIONETA F100</b> ∅ Int. 64 mm    ∅ Ext. 97 mm    ↔ 1.9 mm	<b>COD. 08-05-02</b>  <b>ARANDELA PINADORA F10 - 20 TRASERA</b> ∅ Int. 64 mm    ∅ Ext. 97 mm    ↔ 1.9 mm
--	--

# FORD

**COD. 05-08-01** UN. EMP. 20  
REF. B5A1195



**ARANDELA CACHO AUTO CAMIONETA F100**

∅ Int. 19 mm ∅ Ext. 43.6mm ↔ 2.5 mm

**COD. 05-08-02** UN. EMP. 20  
REF. B5A1195



**ARANDELA CACHO FORD F600 MOD. 56-60**

∅ Int. 22,2 mm ∅ Ext. 51 mm ↔ 2.5 mm

**COD. 05-08-03** UN. EMP. 20  
REF. B5A1195



**ARANDELA CACHO FORD F600 TIPO PESADO/MOD. 65**

∅ Int. 19 mm ∅ Ext. 43.6mm ↔ 2.5 mm

**COD. 05-08-04** UN. EMP. 20  
REF. B5A1195



**ARANDELA CACHO FORD F800**

∅ Int. 26 mm ∅ Ext. 64 mm ↔ 2.5 mm

**COD. 05-08-05** UN. EMP. 20  
REF. B5A1195



**ARANDELA CACHO FORD F900 SIN REPUJADO**

**COD. 05-08-06** UN. EMP. 20  
REF. B5A1195



**ARANDELA CACHO FORD F900 -1000 PIN REPUJADO**

∅ Int. 45 mm ∅ Ext. 84.5 mm ↔ 1.5 mm

**COD. 05-08-07** UN. EMP. 20  
REF. B5A1195



**ARANDELA RODILLON FORD F950 CON PIN**

∅ Int. 57 mm ∅ Ext. 87 mm ↔ 1.5 mm

**COD. 08-08-03** UN. EMP. 10  
REF. B6Y1124



**ARANDELA PINADORA HAUSSING F800**

∅ Int. 51.4 mm ∅ Ext. 75.2mm ↔ 1.9 mm

**COD. 08-08-01** UN. EMP. 10  
REF. 611124



**ARANDELA PINADORA HAUSSING F250**

∅ Int. 46.6 mm ∅ Ext. 71.5 mm ↔ 1.6 mm

**COD. 08-08-04** UN. EMP. 10



**ARANDELA PINADORA HAUSSING F800 TIPO HI**

∅ Int. 67.7 mm ∅ Ext. 101 mm ↔ 1.9 mm

**COD. 08-08-05** UN. EMP. 10  
REF. TUA1124



**ARANDELA PINADORA HOUSSING F900**

∅ Int. 77 mm ∅ Ext. 115 mm ↔ 1.9 mm

**COD. 08-08-06** UN. EMP. 10  
REF. B8QH1124



**ARANDELA PINADORA HAUSSING F950 F1000**

∅ Int. 83.8 mm ∅ Ext. 121 mm ↔ 1.9mm

**COD. 08-08-07** UN. EMP. 10



**ARANDELA PINADORA HAUSSING F950 F1000**

∅ Int. 82 mm ∅ Ext. 121 mm ↔ 1.9 mm

**INTERNATIONAL**

UN. EMP. 10	COD.	DESCRIPCION	∅ Int.	∅ Ext.	↕
	08-10-01	ARANDELA PINADORA HOUSING INTERNATIONAL HI1700	64 mm	97 mm	1.9 mm
	08-10-02	ARANDELA PINADORA HOUSING INTERNATIONAL PICK UP 1310	52 mm	80 mm	1.9 mm
	08-10-03	ARANDELA PINADORA HOUSING PICK UP 1310 DT466 1800 MN	53.3 mm	87 mm	1.9 mm

**INTERNATIONAL**

COD. 08-10-04	UN. EMP. 10
	
ARANDELA PINADORA HOUSING INTERNATIONAL AGRALE	
∅ Int. 64.5 mm ∅ Ext. 107 mm ↕ 1.9 mm	
<b>TIPO HI</b>	

**MAZDA**

COD. 05-16-01	UN. EMP. 10
	
ARANDELA CACHO MAZDA	
∅ Int. 16.8mm ∅ Ext. 35.8 ↕ 1.9 mm	

**NISSAN**

COD. 05-20-01	UN. EMP. 10
	
ARANDELA KIT SEGURO RUEDA DELANTERA NISSAN PICK UP	
∅ Int. 18.5mm ∅ Ext. 42.5 ↕ 2.4 mm	

COD. 08-14-01	UN. EMP. 10
	
ARANDELA PINADORA HAUSSING NISSAN LAND ROVER	
∅ Int. 41.6mm ∅ Ext. 66.4 ↕ 1.5 mm	

COD. 08-20-01	UN. EMP. 10
OEM 43232-45460	
	
ARANDELA PINADORA HAUSSING NISSAN EJE PUENTE DELANTERO	
∅ Int. 41.5 mm ∅ Ext. 66.3 mm ↕ 1.5 mm	

COD. 08-20-02	UN. EMP. 10
OEM 43069-32200	
	
ARANDELA PINADORA HAUSSING NISSAN EJE PUENTE TRASERO	
∅ Int. 40.2 mm ∅ Ext. 63.3 mm ↕ 1.2 mm	

COD. 08-20-03	UN. EMP. 10
	
ARANDELA CAJA NISSAN TREN FIJO	
∅ Int. 25 mm ∅ Ext. 45 mm ↕ 1 mm	

COD. 08-20-05	UN. EMP. 10
	
ARANDELA PINADORA NISSAN /CHEVROLET SAMURAI	
∅ Int. 43.5 mm ∅ Ext. 72 mm ↕ 1.5 mm	

**NISSAN**

COD. 08-24-03	UN. EMP. 10
OEM 43233-C6000	
	
ARANDELA PINADORA HAUSSING RUEDA LIBRE / NISSAN	
∅ Int. 41.5 mm ∅ Ext. 53.4 ↕ 1.5 mm	

**SUZUKI**

COD. 08-23-01	UN. EMP. 10
OEM 43069-32200	
	
ARANDELA PINADORA CHEVROLEY SUZUKI SJ-410	
∅ Int. 40.2 mm ∅ Ext. 63.3 mm ↕ 1.2 mm	

# TOYOTA

<b>COD. 08-24-01</b>	UN. EMP. 10
OEM 90215-38020	
	
<b>ARANDELA PINADORA HAUSSING LAND CRUISER (69-76)</b>	
$\varnothing$ Int. 38.1 mm $\varnothing$ Ext. 60.7 mm $\updownarrow$ 1.2 mm	

<b>COD. 08-24-02</b>	UN. EMP. 10
OEM 90215-42025	
	
<b>ARANDELA PINADORA HAUSSING LAND CRUISER (75-07) / 4RUNNER (84-95) / PICKUP (79-95)</b>	
$\varnothing$ Int. 42.2 mm $\varnothing$ Ext. 61 mm $\updownarrow$ 1.2 mm	

<b>COD. 08-24-04</b>	UN. EMP. 10
REF. 90214-42030	
	
<b>ARANDELA FRICCION LAND CRUISER (75-07) / 4RUNNER (84-95) / PICKUP (79-95)</b>	
$\varnothing$ Int. 42.6 mm $\varnothing$ Ext. 68.6 mm $\updownarrow$ 2.5 mm	

<b>COD. 08-27-01</b>	UN. EMP. 10
REF. A867	
	
<b>ARANDELA PINADORA HOUSSING WILLYS</b>	
$\varnothing$ Int. 41.8 mm $\varnothing$ Ext. 65.4 mm $\updownarrow$ 1.2 mm	

<b>COD. 08-27-02</b>	UN. EMP. 10
REF. A865	
	
<b>ARANDELA PINADORA HOUSSING FRICCION WILLYS</b>	
$\varnothing$ Int. 41.1 mm $\varnothing$ Ext. 57 mm $\updownarrow$ 1.5 mm	

## TUERCAS

COD. 08A-03-01 UN. EMP. 1

REF. AS603



**KIT SEGURO Y TUERCA RUEDA TRASERA**  
ISUZU LUV/ PICKUP / TROOPER 4WD (90...)

1:  $\varnothing$  Int. 39 mm Hex. 57.1 mm  $\updownarrow$  23 mm2:  $\varnothing$  Int. 40 mm  $\varnothing$  Ext. 72.8 mm  $\updownarrow$  4.2mm

COD. 08B-03-01 UN. EMP. 1



TUERCA RUEDA DELANTERA

ISUZU LUV/ PICKUP / TROOPER 4WD (90...)

 $\varnothing$  Int. 39 mm Hex. 57.1 mm  $\leftrightarrow$  23 mm

COD. 08B-03-02 UN. EMP. 5



TUERCA HAUSSING

ISUZU NPR (00 EN ADELANTE)

 $\varnothing$  Int. 55 mm  $\varnothing$  Ext. 91 mm  $\updownarrow$  10.5 mm

COD. 08B-03-03 UN. EMP. 5

REF. 8971370920



ISUZU NKR (00 EN ADELANTE)

 $\varnothing$  Int. 52 mm  $\varnothing$  Ext. 91 mm  $\updownarrow$  12 mm

COD. 08B-05-01 UN. EMP. 5

REF.



TUERCA HOUSING DAIHATSU DELTA M55 x 1.5

Hex. 68.6 mm Rca. Int. M55x1.5  $\updownarrow$  8 mm

COD. 08A-24-00 UN. EMP. 1

REF. AS-602



**KIT SEGUROS Y TUERCAS RUEDA DEL.**  
PICKUP - HILUX 4WD (84 EN ADEL.)

COD. 08B-24-01 UN. EMP. 1

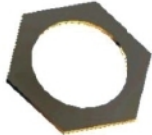

TUERCA RUEDA DELANTERA  
PICKUP - HILUX 4WD (84 EN ADEL.)

COD. 08B-26-01 UN. EMP. 5



TUERCA CACHO DELANTERO SUZUKI LJ80  
VOLKSWAGEN BUSETAS - SUBARU AUTOS

Hex. 36 mm Rca. Int. M24x1.5  $\updownarrow$  19 mm

COD. 69-00-01 UN. EMP. 5



TUERCA CACHO SUZUKI

Hex. 38 mm Rca. Int. M24x1.5  $\updownarrow$  16 mm

COD. 69-00-02 UN. EMP. 5



TUERCA EJE TRASERA DODGE D-600 - WILLYS

Hex. 38 mm Rca. Int. 1" x14h  $\updownarrow$  11 mm

COD. 69-16-01 UN. EMP. 5



TUERCA CACHO MAZDA 323 -R

Hex. 20,64 mm Rca. Int. M16x1.5  $\updownarrow$  16.5 mm

COD. 69-16-02 UN. EMP. 5



TUERCA CACHO MAZDA 323 -L

Hex. 20,64 mm Rca. Int. M16x1.5  $\updownarrow$  16.5 mm

COD. 69-16-03 UN. EMP. 5



TUERCA EJE MAZDA 323

Hex. 28.5 mm Rca. Int. M26x1.5  $\updownarrow$  18.5 mm

COD. 69-24-02 UN. EMP. 1



TUERCA TOYOTA HILUX 22R

Hex. 24 mm Rca. Int. M18x1.5  $\updownarrow$  15 mm

COD. 69-24-03 UN. EMP. 1



TUERCA TOYOTA LAND CRUISER

Hex. 30.2 mm Rca. Int. M20x1.5  $\updownarrow$  16.3 mm

COD. 69-24-04 UN. EMP. 1



TUERCA CACHO TOYOTA COROLLA

Rca. Int. M22x1.5  $\updownarrow$  21 mm

COD. 69-24-05 UN. EMP. 1

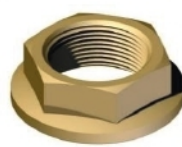

TUERCA TOYOTA VIGO

Hex. 35 mm Rca. Int. M28x1.5  $\updownarrow$  16 mm

## CHEVROLET

COD. 14-00-02 UN. EMP. 1



BISAGRA PUERA TRASERA SUZUKI Y OTROS

COD. 19-03-03 UN. EMP. 1  
REF. 2039437



CHAPA CAPOT C70

COD. 20-03-03 UN. EMP. 2



RECIBIDOR CHEVROLET LUV / DAHIATSU

## CHEVROLET

COD. 21-03-01 UN. EMP. 1  
REF. CTC-3



CONJUNTO TROMPO CAPOT CHEVETTE

COD. 13-06-03 UN. EMP. 1  
REF. CD70-2833307



BISAGRA CAPOT D600 (66-74) -L

COD. 13-06-04 UN. EMP. 1  
REF. CD70-2833308



BISAGRA CAPOT D600 (66-74) -R

## DODGE

COD. 13-06-05 UN. EMP. 1  
REF. CD75-3636307



BISAGRA CAPOT D600 (75-80) -L

COD. 13-06-06 UN. EMP. 1  
REF. CD75-3636308



BISAGRA CAPOT D600 (75-80) -R

COD. 19-06-03 UN. EMP. 1  
REF. CHD2

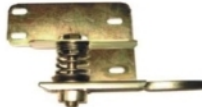

CHAPA CAPOT D600 (69-74)

## DODGE

COD. 19-06-04 UN. EMP. 1  
REF. CHD3



CHAPA CAPOT D600 (75-80)

COD. 21-06-01 UN. EMP. 1  
REF. CTC1



TROMPO CAPOT D600 (75-80)

COD. 21-08-01 UN. EMP. 5  
REF. CTC2



CONJUNTO TROMPO CAPOT F600

## FORD

## NISSAN

COD. 14-00-03 UN. EMP. 1  
REF. A185 L



BISAGRA PUERTA TRASERA -L  
NISSAN / TOYOTA / OTROS

COD. 14-00-04 UN. EMP. 1  
REF. A185 R



BISAGRA PUERTA TRASERA -R  
NISSAN / TOYOTA / OTROS

## RENAULT

COD. 19-21-03 UN. EMP. 1



CHAPA CAPOT R9

## RENAULT

COD. 19-21-04 UN. EMP. 1  
REF. 5159



CHAPA CAPOT R12 DACIA

COD. 19-21-05 UN. EMP. 1



CHAPA Y TROMPO CAPOT R18

COD. 19-21-06 UN. EMP. 1



CHAPA BAUL R9 / R18

**TOYOTA**

COD. 14-00-01 / REF. 564

UN. EMP. 1



**BISAGRA TRASERA CAMPEROS**

COD. 14-00-05

UN. EMP. 1



**BISAGRA MALETERO UNIVERSAL  
 BUSES / BUSETAS / OTROS**

COD. 18-00-01

UN. EMP. 1

REF. A555-1



**CHAPA CABINA ALEMANA -L**

COD. 18-00-02  
 REF. A555-D

UN. EMP. 1



**CHAPA CABINA ALEMANA -R**

COD. 18-00-03

UN. EMP. 1

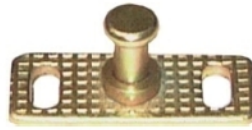

**RECIBIDOR CHAPA CABINA ALEMANA**

COD. 18-00-06

UN. EMP. 1



**CHAPA CABINA ALEMANA -L - CON SEGURO**

COD. 18-00-05

UN. EMP. 1



**CHAPA CABINA ALEMANA -R - CON SEGURO**

COD. 20-24-01

UN. EMP. 2



**RECIBIDOR CHAPA CABINA (78-82)**

COD. 20-24-02

UN. EMP. 2



**RECIBIDOR PUERTA 4.5**

**GANCHOS DE CAPOT**

**WILLYS**

COD. 23-24-02

UN. EMP. 2



**GANCHO CAPOT CROMADO  
 (CON RECIBIDOR Y TORNILLO)**

COD. 23-00-01

UN. EMP. 2



**GANCHO CAPOT CURVO  
 (CON RECIBIDOR Y TORNILLO)**

COD. 23-27-02

UN. EMP. 2



**GANCHO CAPOT WILLYS CROMADO  
 Con recibidor y tornillo**

## SELLOS DE BLOQUE

PRODUCTO	COD.	MEDIDA	DESCRIPCION
UN. EMP. 20	65-00-04	16 mm	TAPON BLOQUE
	65-00-05	18 mm	TAPON BLOQUE
	65-00-46	19 mm	TAPON BLOQUE
	65-00-08	20 mm	TAPON BLOQUE 20 MM CHEVROLET SUZUKI
	65-00-09	21 mm	TAPON BLOQUE
	65-00-10	22 mm	TAPON BLOQUE
	65-00-12	24 mm	TAPON BLOQUE CUMMINS DODGE 600 DIESEL
	65-00-14	25 mm	TAPON BLOQUE
	65-00-39	26 mm	TAPON BLOQUE
	65-00-44	27 mm	TAPON BLOQUE
	65-00-45	28 mm	TAPON BLOQUE
	65-00-21	30 mm	TAPON BLOQUE 30 MM CHEVROLET / SUZUKI / LATERAL NISSAN
	65-00-23	32 mm	TAPON BLOQUE
	65-00-24	34 mm	TAPON BLOQUE CHEVETTE / MONZA / CELEBRITY
	65-00-27	35 mm	TAPON BLOQUE LUV 1.6 - 2.0 - 2.3 / LAND ROVER
	65-00-28	36 mm	TAPON BLOQUE HYUNDAI PONY / MAZDA / FIAT
	65-00-30	40 mm	TAPON BLOQUE NISSAN / WILLYS
	65-08-02	50 mm	TAPON BLOQUE TOYOTA CIGÜEÑAL / NISSAN
	65-00-35	58 mm	TAPON BLOQUE
	65-00-47	5/8"	TAPON BLOQUE
	65-00-40	3/4"	TAPON BLOQUE
	65-00-11	7/8"	TAPON BLOQUE
	65-00-38	15/16"	TAPON BLOQUE CUMMINS DODGE 600 DIESEL
	65-00-34	1"	TAPON BLOQUE
	65-00-18	1 1/16"	TAPON BLOQUE
	65-00-43	1 1/8"	TAPON BLOQUE
	65-00-26	1 3/8"	TAPON BLOQUE LUV 1.6 - 2.0 - 2.3 / LAND ROVER
	65-00-29	1 1/2"	TAPON BLOQUE FORD 289 - 302 - 351 -400 / COMANDO V6
	65-00-37	1 5/8"	TAPON BLOQUE 300 / CHEVROLET 230 - 235 - 250 -350 CA / WILLYS 226
65-00-33	1 3/4"	TAPON BLOQUE CHEVROLET B60 / M366 / F361 - PIRAGUA 272-392 / F600	
65-00-41	1 1/4"	TAPON BLOQUE CULATA D300 / SIMCA	
65-00-42	2"	TAPON BLOQUE CHEVROLET CJ6 CJ7 / CULATA COMANDO EJE DE LEVAS FORD	
65-00-48	2 1/8"	TAPON BLOQUE	

**HORQUILLAS**
**COD. 34-03-01**

UN. EMP. 1

**HORQUILLA EMBRAGUE CHEVETTE (81...)**
**PERNOS**
**COD. 76-24-01 / 69-24-01**

UN. EMP. 5

REF. 45612-35130 / TETD4035

**PERNO BRAZO DIRECCION HILUX - Con tuerca**
 $\varnothing$  22 mm  $\leftrightarrow$  66.5 mm

**COD. 16-03-02**

UN. EMP. 5

OEM 897078270

**PERNO EMBRAGUE ISUZU NKR NPR**
 $\varnothing$  Ext Hex16 mm Rca. Ext.m12 x1.75  $\leftrightarrow$  41 mm

**PERNOS**
**COD. 16-03-03**

UN. EMP. 5

**PERNO EMBRAGUE NPR (MN)**

 Rca. Ext. M14x1.5  $\leftrightarrow$  69 mm

**COD. 16-16-01**

UN. EMP. 5

**PERNO EMBRAGUE MAZDA  
T45 TURBO - BUSETA**
 $\varnothing$  Ext 16 mm Rca. Ext. M10x1.5  $\leftrightarrow$  40 mm

**COD. 16-20-01**

UN. EMP. 5

**PERNO EMBRAGUE NISSAN MT3000 BUSETA**

 Rca. M14 X1.5  $\varnothing$  Ext. 19 mm  $\leftrightarrow$  50 mm

**PERNOS**
**COD. 16-19-01**

UN. EMP. 5

REF. B02230

**PERNO EMBRAGUE CANTER**
 $\varnothing$  Ext. 19mm Rca. M12x1.75mm  $\leftrightarrow$  41 mm

**TAPÓN DE CARTER**
**COD. 65-00-01**

UN. EMP. 5

**TAPON CARTER 14mm**

 Rca. Ext. M14x1.5  $\varnothing$  14mm  $\leftrightarrow$  28 mm

**COD. 65-00-02**

UN. EMP. 100

**ARANDELA TAPON CARTER**
 $\varnothing$  Int. 14 mm  $\varnothing$  Ext. 18 mm  $\updownarrow$  1.5 mm

**TAPON DEL CARTER**
**COD. 65-00-49**

UN. EMP. 5

**TAPON CARTER 10mm**

 Rca. Ext. M10x1.25  $\varnothing$  10mm  $\leftrightarrow$  27 mm

**COD. 65-00-50**

UN. EMP. 5

**TAPON CARTER 12mm**

 Rca. Ext. M12x1.25  $\varnothing$  12mm  $\leftrightarrow$  27 mm

**COD. 65-00-51**

UN. EMP. 5

**TAPON CARTER 1/2"**

 Rca. Ext. 1/2 - 20NF  $\varnothing$  1/2"  $\leftrightarrow$  25.5 mm

**COD. 65-00-52**

UN. EMP. 5

**TAPON CARTER 18mm**

 Rca. Ext. M18x1.5  $\varnothing$  18mm  $\leftrightarrow$  28 mm

**COD. 65-00-53**

UN. EMP. 5

**TAPON CARTER 20mm**

 Rca. Ext. M20x1.5  $\varnothing$  20mm  $\leftrightarrow$  27 mm

**COD. 65-00-54**

UN. EMP. 5

**TAPON CARTER 22mm**

 Rca. Ext. M22x1.5  $\varnothing$  22mm  $\leftrightarrow$  34 mm

## TORNILLOS VARIOS

	UN. EMP. 1
<b>TORNILLO PARA FIJACION M10x1</b>	

	UN. EMP. 1
<b>TORNILLO PARA FIJACION M10x1.25</b>	

	UN. EMP. 2
<b>TORNILLO BARRA DIRECCION TERMINAL (Caña) LUV 2300 / ISUZU / TROOPER 2WD - Largo</b>	
Tor. Rca. Ext. M14x1.5 Izq. Der	↔ 210 mm
Hex. Central 14 mm	

	UN. EMP. 2
<b>TORNILLO BARRA DIRECCION TERMINAL (Caña) LUV 2300 / ISUZU / TROOPER 4WD - Corto</b>	
Tor. Rca. Ext. M14x1.5 Izq. Der	↔ 170 mm
Hex. Central 14 mm	

	UN. EMP. 5
<b>TORNILLO MORDAZA SUP. MAZDA B1600 / 2000</b>	
Ø 13.5 mm ↔ 117 mm Rosca Ext. M14x1.5	

	UN. EMP. 2
<b>TORNILLO BARRA DIRECCION TERMINAL (Caña) MAZDA B200 / 2200 / 2600 / BT50</b>	
Hex Ø 13.5 mm Rsc M14x1.5(L) ® ↔ 117mm	

	UN. EMP. 2
<b>TORNILLO BARRA DIRECCIÓN TERMINAL (CAÑA) NISSAN FRONTIER 4WD</b>	
Ø 16mm ↔ 165 mm Rosca Ext. M14x1.5 Izq - Der	

## QUEMADORES

	UN. EMP. 20
<b>QUEMADOR BUJIA 12mm TABAQUITO</b>	

	UN. EMP. 20
<b>QUEMADOR BUJIA 14mm - Corto</b>	

	UN. EMP. 20
<b>QUEMADOR BUJIA 14mm - Largo</b>	

	UN. EMP. 20
<b>QUEMADOR BUJIA 18mm</b>	

	UN. EMP. 20
<b>QUEMADOR BUJIA 12mm TABAQUITO - Largo</b>	

	UN. EMP. 20
<b>QUEMADOR BUJIA 14mm largo - Hueco 5mm</b>	

	UN. EMP. 20
<b>QUEMADOR BUJIA 14mm corto - Hueco 5mm Plano</b>	

	UN. EMP. 20
<b>QUEMADOR BUJIA 12mm - Corto Hueco de 5mm - Cónico</b>	

	UN. EMP. 20
<b>QUEMADOR BUJIA 12mm - Largo Hueco de 5mm - Cónico</b>	

	UN. EMP. 20
<b>QUEMADOR BUJIA 18mm - Hueco 5mm -Plano</b>	

	UN. EMP. 20
<b>QUEMADOR BUJIA 14mm Xlargo- Hueco 5mm Plano</b>	

	UN. EMP. 20
<b>QUEMADOR BUJIA M14x1.25 3 HCOS PLANO FULL INYECCION</b>	

### CHEVROLET CAMIONETAS - PICK UPS



### CHEVROLET CAMION

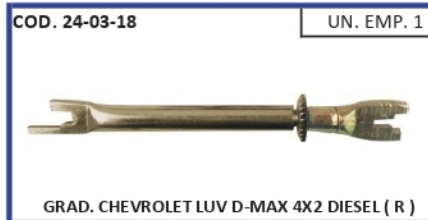

## DAEWOO

COD. 24-04-01  
REF. 11104

UN. EMP. 1



GRADUACION DAEWOO RACER / CIELO -R

COD. 24-04-02  
REF. 11104-1

UN. EMP. 1



GRADUACION DAEWOO RACER / CIELO -L

## DAIHATSU

COD. 24-05-01  
REF. 11168-4

UN. EMP. 1



GRADUACION FRENO DAHATSU DELTA - L

## DAHATSU

COD. 24-05-02  
REF. 11168-3

UN. EMP. 1



GRADUACION DAHATSU DELTA - R

COD. 24-05-03  
REF. 11168

UN. EMP. 1



GRADUACION F20 / FERROZA

## DODGE

COD. 24-06-01  
REF. 11121

UN. EMP. 1



GRADUACION D300 MN -L

## DODGE

COD. 24-06-02  
REF. 11120

UN. EMP. 1



GRADUACION D300 MN -R

COD. 24-00-07  
REF. 11116 / C6TZL

UN. EMP. 1



GRADUACION D300 (73-90) / F350 (MN) -L

COD. 24-00-08  
REF. 11115 / C67ZR

UN. EMP. 1



GRADUACION D300 (73-90) / F350 (MN) -R

## FORD

COD. 24-08-01  
REF. 11145R

UN. EMP. 1



GRADUACION FORD AUTO TODOS -R

COD. 24-08-02  
REF. B7A

UN. EMP. 1



GRADUACION F350 -R  
Diente Grueso

COD. 24-08-03

UN. EMP. 1



GRADUACION FRENO FORD F600 - R

COD. 24-08-04  
REF. 11145L

UN. EMP. 1



GRADUACION FORD AUTO TODOS -L

COD. 24-08-05  
REF. B7A-1

UN. EMP. 1



GRADUACION F350 -L  
Diente Grueso

COD. 24-08-06

UN. EMP. 1



GRADUACION FRENO FORD F600 - L

## FORD

COD. 24-08-07

UN. EMP. 1



GRADUACION FORD MOD. NUEVO F350 -R

COD. 24-08-08

UN. EMP. 1



GRADUACION FORD MOD. NUEVO F350 -L

COD. 24-08-09

UN. EMP. 1

REF. ZAGF- 1521R



GRADUACION FORD / JEEP / CHEROKEE / WILLYS  
11" - R - Diente Fino

**FORD**
**COD. 24-08-10** UN. EMP. 1  
 REF. ZAGF-1521L

**GRADUACION FORD/ JEEP/ CHEROKEE/ WILLYS**  
 11" - L -Diente Fino

**HYUNDAI**
**COD. 24-09-01** UN. EMP. 1  
 REF. 10101

**GRADUACION ACCENT ATOS -R**
**COD. 24-09-02** UN. EMP. 1  
 REF. 10102

**GRADUACION ACCENT ATOS -L**
**MAZDA B2000 / 2200 / 2600**
**COD. 24-16-01** UN. EMP. 1  
 REF. 11112

**GRADUACION MAZDA B2000-2200**  
 MITSUBISHI MONTERO (PAJERO) 2.4 2.6 3.0 -R

**COD. 24-16-02** UN. EMP. 1  
 REF. 11112-1

**GRADUACION MAZDA B2000-2200**  
 MITSUBISHI MONTERO (PAJERO) 2.4 2.6 3.0 -L

**COD. 24-16-03** UN. EMP. 1  
 REF. 11166-5

**GRADUACION MAZDA TURBO 3000 DIESEL 1 1/8"**
**MAZDA B2000 / 2200 / 2600**
**COD. 24-16-04** UN. EMP. 1

**GRADUACION MAZDA BT 50**  
 TODOS ( R )

**COD. 24-16-05** UN. EMP. 1

**GRADUACION MAZDA BT 50**  
 TODOS ( L )

**NISSAN**
**COD. 24-20-03** UN. EMP. 1  
 REF. 11124-1

**GRADUACION PICKUP D21 (93-03) / URVAN -R**
**NISSAN**
**COD. 24-20-04** UN. EMP. 1  
 REF. 11124-2

**GRADUACION PICKUP D21 (93-03) / URVAN -L**
**COD. 24-20-05** UN. EMP. 1  
 REF. 11123 / A10101

**GRADUACION SENTRA B13 TODOS /**  
 TSURU III (94-07) -R

**COD. 24-20-06** UN. EMP. 1  
 REF. 11123-1 / A10102

**GRADUACION SENTRA B13 TODOS /**  
 TSURU III (94-07) -L

**TOYOTA AUTOMOVILES**
**COD. 24-24-09** UN. EMP. 1  
 REF. 11141

**GRADUACION TERCEL -R**
**COD. 24-24-10** UN. EMP. 1  
 REF. 11142

**GRADUACION TERCEL -L**
**COD. 24-24-15** UN. EMP. 1  
 REF. 11143

**GRADUACION COROLLA (83-88) -R**
**TOYOTA AUTOMOVILES**
**COD. 24-24-16** UN. EMP. 1  
 REF. 11144















**GRADUACION COROLLA (83-88) -L**
**TOYOTA CAMPEROS / CAMIONETAS / PICK-UPS**
**COD. 24-24-01** UN. EMP. 1  
 REF. 11157

**GRADUACION HILUX (82) -R**  
 DIENTE FINO - FRESADO ANGOSTO

**COD. 24-24-02** UN. EMP. 1  
 REF. 11157-1

**GRADUACION HILUX (82) -L**  
 DIENTE FINO - FRESADO ANGOSTO

## TOYOTA CAMPEROS / CAMIONETAS / PICK-UPS

<p><b>COD. 24-24-03</b> UN. EMP. 1 REF. 11158</p>  <p><b>GRADUACION HILUX (82) -R</b> <b>DIENTE FINO - FRESADO ANCHO</b></p>	<p><b>COD. 24-24-04</b> UN. EMP. 1 REF. 11158-1</p>  <p><b>GRADUACION HILUX (82) -L</b> <b>DIENTE FINO - FRESADO ANCHO</b></p>	<p><b>COD. 24-24-05</b> UN. EMP. 1 REF. 11159-2</p>  <p><b>GRADUACION HILUX -R</b> <b>DIENTE ORDINARIO - FRESADO ANGOSTO</b></p>
<p><b>COD. 24-24-06</b> UN. EMP. 1 REF. 11159-3</p>  <p><b>GRADUACION HILUX -L</b> <b>DIENTE ORDINARIO - FRESADO ANGOSTO</b></p>	<p><b>COD. 24-24-07</b> UN. EMP. 1 REF. 11155</p>  <p><b>GRADUACION HILUX MV -R</b> <b>DIENTE ORDINARIO - FRESADO ANCHO</b></p>	<p><b>COD. 24-24-08</b> UN. EMP. 1 REF. 11156</p>  <p><b>GRADUACION HILUX MV -L</b> <b>DIENTE ORDINARIO - FRESADO ANCHO</b></p>
<p><b>COD. 24-24-11</b> UN. EMP. 1 REF. 11154</p>  <p><b>GRADUACION PICKUP 2WD V. AMERICANA -R</b></p>	<p><b>COD. 24-24-12</b> UN. EMP. 1 REF. 11154-1</p>  <p><b>GRADUACION PICKUP 2WD V. AMERICANA -L</b></p>	<p><b>COD. 24-24-13</b> UN. EMP. 1 REF. 11159</p>  <p><b>GRADUACION HILUX 4WD /CRESSIDA (74-80) -R</b></p>
<p><b>COD. 24-24-14</b> UN. EMP. 1 REF. 11159-1</p>  <p><b>GRADUACION HILUX 4WD /CRESSIDA (74-80) -L</b></p>	<p><b>COD. 24-24-17</b> UN. EMP. 1 REF. 11159-4</p>  <p><b>GRADUACION 4.5 LAND CRUISER (75-90)</b> <b>4RUNNER (85-00) -R</b></p>	<p><b>COD. 24-24-18</b> UN. EMP. 1 REF. 11159-5</p>  <p><b>GRADUACION 4.5 LAND CRUISER (75-90)</b> <b>4RUNNER (85-00) -L</b></p>
<p><b>COD. 24-24-19</b> UN. EMP. 1</p>  <p><b>GRADUACION FRENO TOYOTA VIGO 4X4</b> <b>MOD. 08/10, R</b></p>	<p><b>COD. 24-24-20</b> UN. EMP. 1</p>  <p><b>GRADUACION FRENO TOYOTA VIGO 4X4</b> <b>MOD. 08/10, L</b></p>	

**PIVOTES**

COD. 55-00-01 UN. EMP. 20



PIVOTE CILINDRO FRENO - Corto

COD. 55-00-02 UN. EMP. 20



PIVOTE CILINDRO FRENO - Largo

COD. 55-00-03 UN. EMP. 20



PIVOTE CILINDRO FRENO CHEVROLET / DODGE

**PUNTILLA PARA FRENOS**

COD. BEL JPG-12 UN. EMP. 1



PUNTILLA FRENO NPR - 89mm (Juego)

COD. BEL JPG-10 (Gruesa) UN. EMP. 1

COD. BEL JPG-11 (Delgada)



PUNTILLA FRENO CURVA (Juego)

PRODUCTO	COD.	DESCRIPCIÓN	↔	UN. EMP.
	75-00-01	PUNTILLA FRENO 34 mm	34 mm	<b>1 JUEGO</b> 2 Puntillas 2 Resortes 4 cazuelas
	75-21-01	PUNTILLA FRENO 37 mm (R9)	37 mm	
	75-00-02	PUNTILLA FRENO 39 mm	39 mm	
	75-03-02	PUNTILLA FRENO 42 mm (LUV/SPRINT)	42 mm	
	75-00-03	PUNTILLA FRENO 46 mm	46mm	
	75-00-04	PUNTILLA FRENO 50 mm	50 mm	
	75-00-05	PUNTILLA FRENO 54 mm	54 mm	
	75-00-09	PUNTILLA FRENO 60 mm	60 mm	
	75-00-06	PUNTILLA FRENO 63.5 mm	63.5 mm	
	75-00-10	PUNTILLA FRENO 68 mm	68 mm	
	75-03-03	PUNTILLA FRENO 70 mm	70 mm	
75-00-11	PUNTILLA FRENO 73 mm	73 mm		

**TORNILLOS PARA FRENOS**

COD. 76-03-01 UN. EMP. 1



TORNILLO MORDAZA LUV 2300

 Tornillo Rca. Ext. M10x1 Cabeza Hex. 9.3 mm  
 ↔ 63.5 mm

COD. 76-03-06 UN. EMP. 1

 TORNILLO MORDAZA TRASERO  
 CHEVROLET TROOPER

 Tornillo Rca. Ext. M8x1.25 Cabeza Hex. 13 mm  
 ↔ 65.5 mm

COD. 76-03-07 UN. EMP. 1

 TORNILLO MORDAZA DELANTERO  
 CHEVROLET LUV Y TROOPER

 Tornillo Rca. Ext. M10x1.25 Cabeza Hex. 15 mm  
 ↔ 70 mm

COD. 76-16-02 UN. EMP. 1



TORNILLO BARRA DIRECCION MAZDA B 2000/2200/2600

 Tornillo Rca. Ext. M10x1.25 Cabeza Hex. 15 mm  
 ↔ 70 mm

## SEPARADORES DE CARRETA

COD. 71-00-01

UN. EMP. 5



PASADOR HORQUILLA CAMARA UNIVERSAL

COD. 71-00-02

UN. EMP. 5



SEPARADOR CARRETA PEQUEÑO

COD. 71-00-03

UN. EMP. 5

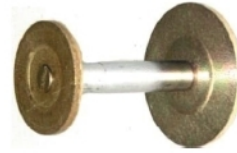

SEPARADOR CARRETA TIPO 30 GRANDE

COD. 71-00-05

UN. EMP. 5



SEPARADOR CARRETA TIPO 24  
NPR / NQR / JAC / AGRALE

## BALANCINES

### UNIVERSAL

COD. 77-00-01

UN. EMP. 1

REF: B77-217



BALANCIN CON PASADOR DE 9/16"  
Pasador :  $\varnothing$  9/16"

COD. 77-00-02

UN. EMP. 1

REF: B77-124



BALANCIN CON PASADOR DE 5/8"  
Pasador :  $\varnothing$  5/8"

### CHEVROLET

COD. 77-03-03

UN. EMP. 1



BALANCIN CON BUJE LUV 1600  
BUJE:  $\updownarrow$  38 mm  $\varnothing$  Ext: 32mm  $\varnothing$  Int.: 18mm  
Pasador :  $\varnothing$  18 mm

### CHEVROLET

COD. 77-03-05

UN. EMP. 1



BALANCIN CON BUJE ISUZU LUV 2300  
HB Original

BUJE 1:  $\updownarrow$  41 mm  $\varnothing$  Ext: 30 mm  $\varnothing$  Int.: 18 mm  
BUJE 2:  $\updownarrow$  34 mm  $\varnothing$  Ext.: 30mm  $\varnothing$  Int.: 18 mm  
Pasador :  $\varnothing$  18 mm

COD. 77-03-05C

UN. EMP. 1



BALANCIN CON BUJE ISUZU LUV 2300  
Original - Cruzado

BUJE 1:  $\updownarrow$  41 mm  $\varnothing$  Ext.: 30 mm  $\varnothing$  Int.: 18 mm  
BUJE 2:  $\updownarrow$  34 mm  $\varnothing$  Ext.: 30 mm  $\varnothing$  Int.: 18 mm  
Pasador :  $\varnothing$  18 mm

COD. 77-03-09

UN. EMP. 1



BALANCIN CON BUJE ISUZU LUV 2300 /  
TROOPER - Largo

BUJE 1:  $\updownarrow$  41 mm  $\varnothing$  Ext.: 30 mm  $\varnothing$  Int.: 18 mm  
BUJE 2:  $\updownarrow$  34 mm  $\varnothing$  Ext.: 30 mm  $\varnothing$  Int.: 18 mm  
Pasador :  $\varnothing$  18 mm

COD. 77-03-04

UN. EMP. 1



BALANCIN CON BUJE ISUZU / TROOPER

BUJE 1:  $\updownarrow$  41 mm  $\varnothing$  Ext.: 30 mm  $\varnothing$  Int.: 18 mm  
BUJE 2:  $\updownarrow$  41 mm  $\varnothing$  Ext.: 30 mm  $\varnothing$  Int.: 18 mm  
Pasador :  $\varnothing$  18 mm

COD. 77-03-06

UN. EMP. 1



BALANCIN CON BUJE SAMURAI (Muelle corto)

BUJE:  $\updownarrow$  36 mm  $\varnothing$  Ext. 30 mm  $\varnothing$  Int. 12.4 mm  
Pasador  $\varnothing$  Ext. 12.4 mm  
 $\varnothing$  Int. 18 mm  $\varnothing$  Ext. 39.8 mm  $\leftrightarrow$  38.3 mm

COD. 77-23-01

UN. EMP. 1



BALANCIN CON BUJE SUZUKI

BUJE:  $\updownarrow$  36 mm  $\varnothing$  Ext. 30 mm  $\varnothing$  Int. 12.4 mm  
Pasador  $\varnothing$  Ext. 12.4 mm

**DAHIATSU**

**HYUNDAI**

**MAZDA**

**MITSUBISHI**

**MITSUBISHI**

**NISSAN**



## NISSAN

<b>COD. 77-20-02</b>	<b>UN. EMP. 1</b>
	
<b>BALANCIN CON BUJE D21</b>	
BUJE: $\updownarrow$ 37 mm $\varnothing$ Ext. 33 mm $\varnothing$ Int. 18 mm Pasador: $\varnothing$ Ext. 18 mm	

<b>COD. 77-20-04</b>	<b>UN. EMP. 1</b>
	
<b>BALANCIN CON BUJE D21 (Buje RB210)</b>	
BUJE 1: $\updownarrow$ 37 mm $\varnothing$ Ext. 33 mm $\varnothing$ Int. 18 mm BUJE 2: $\updownarrow$ 70 mm $\varnothing$ Ext. 33 mm $\varnothing$ Int. 11 mm Pasador 1: $\varnothing$ Ext. 18 mm - Pasador 2: $\varnothing$ Ext. 11mm	

<b>COD. 77-20-05</b>	<b>UN. EMP. 1</b>
	
<b>BALANCIN NISSAN D-21 CON BUSHING (Buje RB210)</b>	
BUJE 1: $\updownarrow$ 66 mm $\varnothing$ Ext. 33 mm $\varnothing$ Int. 12 mm BUJE 2: $\updownarrow$ 36 mm $\varnothing$ Ext. 33 mm $\varnothing$ Int. 20 mm Pasador 1: $\varnothing$ Ext. 12 mm - Pasador 2: $\varnothing$ Ext. 20mm	

## TOYOTA

<b>COD. 77-24-01</b> OEM 04483-60060	<b>UN. EMP. 1</b>
	
<b>BALANCIN CON BUJE DEL. - TRAS. LAND CRUISER FJ75 - BJ40 / 4.5 (80)</b>	
BUJE 1: $\updownarrow$ 47 mm $\varnothing$ Ext. 40 mm $\varnothing$ Int. 18 mm BUJE 2: $\updownarrow$ 47 mm $\varnothing$ Ext. 40 mm $\varnothing$ Int. 18 mm PAS. 1 Y 2: $\varnothing$ 18 mm	

<b>COD. 77-24-02</b> OEM 04481-60020	<b>UN. EMP. 1</b>
	
<b>BALANCIN CON BUJE LAND CRUISER BJ42 - BJ60 - BJ70 (81-87)</b>	
BUJE 1: $\updownarrow$ 43 mm $\varnothing$ Ext. 35 mm $\varnothing$ Int. 18 mm BUJE 2: $\updownarrow$ 43 mm $\varnothing$ Ext. 35 mm $\varnothing$ Int. 18 mm PAS. 1 Y 2: $\varnothing$ 18 mm	

<b>COD. 77-24-03</b> OEM 04481-60011	<b>UN. EMP. 1</b>
	
<b>BALANCIN CON BUJE DEL. LAND CRUISER (...80)</b>	
BUJE 1: $\updownarrow$ 39 mm $\varnothing$ Ext. 26mm $\varnothing$ Int. 16 mm BUJE 2: $\updownarrow$ 39 mm $\varnothing$ Ext. 26mm $\varnothing$ Int. 16 mm PAS. 1 Y 2: $\varnothing$ 16 mm	

<b>COD. 77-24-04</b> OEM 04483-35050	<b>UN. EMP. 1</b>
	
<b>BALANCIN CON BUJE TRAS. HILUX 2WD / 4RUNNER (89-92) -Largo LN 1111 - 135 / RN 110 - 135</b>	
BUJE 1: $\updownarrow$ 33 mm $\varnothing$ Ext. 30 mm $\varnothing$ Int. 18 mm BUJE 2: $\updownarrow$ 48 mm $\varnothing$ Ext. 30 mm $\varnothing$ Int. 18 mm PAS. 1 $\varnothing$ 18 mm PAS. 2 $\varnothing$ 18mm	

<b>COD. 77-24-05</b> OEM 04481-35040	<b>UN. EMP. 1</b>
	
<b>BALANCIN CON BUJE DEL. HILUX 4WD (79-86) / 4RUNNER (84-86) RN 105 G / LN 106 D / YN 106G</b>	
BUJE 1: $\updownarrow$ 53 mm $\varnothing$ Ext. 30mm $\varnothing$ Int. 18 mm BUJE 2: $\updownarrow$ 40 mm $\varnothing$ Ext. 30mm $\varnothing$ Int. 18 mm PAS. 1 $\varnothing$ 18 mm PAS. 2 $\varnothing$ 18mm	

<b>COD. 77-24-06</b> OEM 04483-35040	<b>UN. EMP. 1</b>
	
<b>BALANCIN CON BUJE TRAS. HILUX (79-89) / 4RUNNER (84-89) RN 105 / LN 106 / YN 106</b>	
BUJE 1: $\updownarrow$ 40 mm $\varnothing$ Ext. 30.5 mm $\varnothing$ Int. 18 mm BUJE 2: $\updownarrow$ 32 mm $\varnothing$ Ext. 30.5 mm $\varnothing$ Int. 18 mm PAS. 1 $\varnothing$ 18 mm PAS. 2 $\varnothing$ 18 mm	

<b>COD. 77-24-07</b> OEM 04483-35060	<b>UN. EMP. 1</b>
	
<b>BALANCIN CON BUJE TRAS. HILUX 4WD (89-92)/ 4RUNNER 4WD (89-92) / TACOMA (95)</b>	
BUJE 1: $\updownarrow$ 48 mm $\varnothing$ Ext. 30.5 mm $\varnothing$ Int. 18 mm BUJE 2: $\updownarrow$ 66 mm $\varnothing$ Ext. 40 mm $\varnothing$ Int. 15 mm PAS. 1 $\varnothing$ 18 mm PAS. 2 $\varnothing$ 14.3 mm	

<b>COD. 77-24-08</b> OEM 04481-60011	<b>UN. EMP. 1</b>
	
<b>BALANCIN TOYOTA VIGO / HILUX TRAS.</b>	
BUJE 1: $\updownarrow$ 53.5 mm $\varnothing$ Ext. 30mm $\varnothing$ Int. 20 mm BUJE 2: $\updownarrow$ 32 mm $\varnothing$ Ext. 30mm $\varnothing$ Int. 20 mm PAS. 1 $\varnothing$ 20 mm Y 2: $\varnothing$ 20 mm	

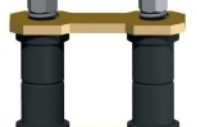
<b>COD. 77-24-09</b> OEM	<b>UN. EMP. 1</b>
	
<b>BALANCIN TOYOTA 4.5 DELANTERO (CORTO)</b>	
BUJE 1: $\updownarrow$ 44 mm $\varnothing$ Ext. 35mm $\varnothing$ Int. 18 mm BUJE 2: $\updownarrow$ 44 mm $\varnothing$ Ext. 35mm $\varnothing$ Int. 18 mm PAS. 1 $\varnothing$ 18 mm Y 2: $\varnothing$ 18 mm	

<b>COD. 77-24-10</b> OEM	<b>UN. EMP. 1</b>
	
<b>BALANCIN TOYOTA 4.5 TRASERO (LARGO)</b>	
BUJE 1: $\updownarrow$ 44 mm $\varnothing$ Ext. 35mm $\varnothing$ Int. 18 mm BUJE 2: $\updownarrow$ 44 mm $\varnothing$ Ext. 35mm $\varnothing$ Int. 18 mm PAS. 1 $\varnothing$ 18 mm Y 2: $\varnothing$ 18 mm	

<b>COD. 77-24-11</b> OEM	<b>UN. EMP. 1</b>
	
<b>BALANCIN TOYOTA STOUT</b>	
BUJE 1: $\updownarrow$ 86 mm $\varnothing$ Ext. 1:25mm $\varnothing$ Int. 0 mm BUJE 2: $\updownarrow$ 74 mm $\varnothing$ Ext. 2:25mm $\varnothing$ Int. 0 mm PAS. 1 $\varnothing$ 18 mm Y 2: $\varnothing$ 18 mm	

**CHEVROLET**

COD. 77B-03-01  <b>BUJE BALANCIN DEL. NPR</b> ∅ Int. 16.4 mm ∅ Ext. 42.3 mm ↔ 73.1 mm	UN. EMP. 10	COD. 77B-03-02  <b>BUJE BALANCIN TRAS. NPR</b> ∅ Int. 16.4 mm ∅ Ext. 54.3 mm ↔ 45 mm	UN. EMP. 10	COD. 77B-03-03  <b>BUJE BALANCIN LUV 1600</b> ∅ Int. 18 mm ∅ Ext. 39.8 mm ↔ 38.3 mm	UN. EMP. 10
COD. 77B-03-04  <b>BUJE BALANCIN ISUZU TROOPER</b> ∅ Int. 18 mm ∅ Ext. 35.5 mm ↔ 35 mm	UN. EMP. 10	COD. 77B-03-05  <b>BUJE BALANCIN LUV 2300 - Original</b> ∅ Int. 18 mm ∅ Ext. 35.5 mm ↔ 35 mm	UN. EMP. 10	COD. 77B-03-06  <b>BUJE BALANCIN SAMURAI</b> ∅ Int. 12.4 mm ∅ Ext. 36 mm ↔ 36.6 mm	UN. EMP. 10
COD. 77B-03-07  <b>BUJE BALANCIN TRAS. NKR</b> ∅ Int. 16 mm ∅ Ext. 40 mm ↔ 73.3 mm	UN. EMP. 10	COD. 77B-03-08  <b>BUJE BALANCIN DEL. NKR / HYUNDAI COUNTY TRAS.</b> ∅ Int. 22.5 mm ∅ Ext. 42.4 mm ↔ 39 mm	UN. EMP. 10	COD. 77B-03-09  <b>BUJE BALANCIN LUV 2300 - Platina larga</b> ∅ Int. 18 mm ∅ Ext. 35.5 mm ↔ 35 mm	UN. EMP. 10
COD. 77B-03-10  <b>BUJE BALANCIN TRAS. NHR</b> ∅ Int. 22.5 mm ∅ Ext. 55.3 mm ↔ 38 mm	UN. EMP. 10	COD. 77B-03-11  <b>BUJE PASADOR NPR MOD. 97-99/2000 TRA PARTE DELANTERA (RB-440)</b> ∅ Int. 18 mm ∅ Ext. 42.5 mm ↔ 81 mm	UN. EMP. 10	COD. 77B-23-02  <b>BUJE BALANCIN SUZUKI - Platina Larga</b> ∅ Int. 12.4 mm ∅ Ext. 36 mm ↔ 36.6 mm	UN. EMP. 10

**CHEVROLET**

COD. 17A-03-02  <b>BUJE NPR MOD. NUEVO</b> ∅ Int. 18 mm ∅ Ext. 42 mm ↔ 81 mm	UN. EMP. 10
--	-------------

**DAHIATSU**

COD. 77B-05-02L  <b>BUJE BALANCIN DAHIATSU CAMPERO - Largo</b> ∅ Int. 15 mm ∅ Ext. 31 mm ↔ 41.5 mm	UN. EMP. 10
--	-------------

**HONDA**

COD. 17A-28-01  <b>BUJE BALANCIN NISSAN D-21 (RB-210)</b> ∅ Int. 12 mm ∅ Ext. 32 mm ↔ 35 mm	UN. EMP. 10
---	-------------

**HYUNDAI**

COD. 17A-09-01  <b>BUJE HYUNDAI COUNTY</b> ∅ Int. 19.5 mm ∅ Ext. 60 mm ↔ 46mm	UN. EMP. 10
---	-------------

**MAZDA**

COD. 17A-16-01  <b>BUJE DEL. AMORTIGUADOR MAZDA BT50/FORD RANGER</b> ∅ Int. 13.3 mm ∅ Ext. 40 mm ↔ 38 mm	UN. EMP. 10
--	-------------

**MITSUBISHI**

COD. 77B-19-02 OEM 90385-23037  <b>BUJE BALANCIN TRAS. MITSUBISHI CANTER / TOYOTA DYNA (86-03) / COASTER (82-93)/ NKR</b>	UN. EMP. 10
---	-------------

## MITSUBISHI

**COD. 77B-19-02C** UN. EMP. 10  
OEM 8-94249-427-0



**BUJE BALANCIN**  
MITSUBISHI / TOYOTA DYNA / ISUZU NKR

∅ Int. 23 mm ∅ Ext. 43 mm ↔ 47 mm

**COD. 77C-19-02** UN. EMP. 10  
OEM 8-94249-427-0



**CASQUETE BUJE BALANCIN**  
MITSUBISHI / TOYOTA DYNA / ISUZU NKR

∅ Int. 39.2 mm ∅ Ext. 43 mm ↔ 36 mm

## NISSAN

**COD. 17-20-01** UN. EMP. 10  
OEM 54542-25610



**BUJE TIJERA DELANTERO**  
NISSAN FRONTIER NP 300

∅ Int. 14.2 mm ∅ Ext. 45 ↔ 55.30

## NISSAN

**COD. 17A-20-01** UN. EMP. 30  
REF. 55045-B0700



**BUJE DE BALANCIN TRASERO NISSAN 620 - 720**  
CAUCHO

∅ Int. 15 mm ∅ Ext. 33 ↔ 35 mm

**COD. 77B-20-04** UN. EMP. 30  
REF.



**BUJE DE BALANCIN NISSAN D-21 (RB-210)**

∅ Int. 11.5 mm ∅ Ext. 33 ↔ 70 mm

## TOYOTA

**COD. 77B-24-02** UN. EMP. 10  
OEM 90389-18002



**BUJE BALANCIN TOYOTA**  
LAND CRUISER (81-90)

∅ Int. 18 mm ∅ Ext. 43.2 mm ↔ 43.8 mm

## TOYOTA

**COD. 17A-24-02R** UN. EMP. 10  
OEM 90385-18046R



**BUJE DE BALANCIN TRASERO**  
HILUX TODAS LAS SERIES / ISUZU TROOPER KB / AMIGO  
RODEO TODAS / CHEVY LUV / CAUCHO REFORZADO CON  
NYLON

∅ Int. 17.5 mm ∅ Ext. 29.5 mm ↔ 34 mm

**COD. 17A-24-05** UN. EMP. 10



**BUJE AMORTIGUADOR TOYOTA TACOMA KAYABA**

∅ Int. 14 mm ∅ Ext. 35 mm ↔ 41 mm

**COD. 17A-24-06** UN. EMP. 10  
OEM 90389-14048



**BUJE AMORTIGUADOR (90389-89012)**  
TACOMA (95-04) / HILUX (02-09) / 4RUNNER (02-09) /  
JFCRUISER (06-07) / LAND CRUISER (96-09) / TOKICO

∅ Int. 14 mm ∅ Ext. 40.4 mm ↔ 41 mm

**COD. 17A-24-08** UN. EMP. 10



**BUJE AMORTIGUADOR TOYOTA TACOMA MONROE**

∅ Int. 14.5 mm ∅ Ext. 37 mm ↔ 40 mm

**COD. 17-00-17** UN. EMP. 10  
OEM 4806136020



**BUJE SUSPENSION TOYOTA COASTER / DYNA**

∅ Int. 18 mm ∅ Ext. 50 mm ↕ 87 mm

**COD. 17-24-01** UN. EMP. 5  
OEM 90389-16018



**BUJE BALANCIN. DEL. PTE. TRAS.**  
TOYOTA COASTER (98 EN ADELANTE)

∅ Int. 16 mm ∅ Ext. 60 mm ↕ 91 mm

**COD. 17A-24-07** UN. EMP. 5



∅ Int. 16 mm ∅ Ext. 60 mm ↕ 91 mm

## PASADORES HOJA DE RESORTE

### CHEVROLET

<p><b>COD. 50B-03-01</b> <span style="float: right;">UN. EMP. 2</span></p>  <p><b>PASADOR HOJA RESORTE DEL. ISUZU FORWARD</b></p> <p style="text-align: center;">∅ 25 mm ↔ 117 mm Engrasador: Chaveta</p>	<p><b>COD. 50B-03-02</b> <span style="float: right;">UN. EMP. 2</span></p>  <p><b>PASADOR HOJA RESORTE TRAS. ISUZU FTR</b></p> <p style="text-align: center;">∅ 28 mm ↔ 131 mm Engrasador: Chaveta</p>	<p><b>COD. 50B-03-03</b> <span style="float: right;">UN. EMP. 2</span></p>  <p><b>PASADOR HOJA RESORTE ISUZU (#1)</b></p> <p style="text-align: center;">∅ 25 mm ↔ 121 mm Engrasador: Chaveta</p>
<p><b>COD. 50B-03-04</b> <span style="float: right;">UN. EMP. 2</span></p>  <p><b>PASADOR HOJA RESORTE ISUZU (#2)</b></p> <p style="text-align: center;">∅ 32 mm ↔ 136 mm Engrasador: Chaveta</p>	<p><b>COD. 50B-03-05</b> <span style="float: right;">UN. EMP. 2</span></p>  <p><b>PASADOR HOJA RESORTE TRAS. ISUZU/HINO (#7)</b></p> <p style="text-align: center;">∅ 25 mm ↔ 116 mm Engrasador: Chaveta</p>	<p><b>COD. 50B-03-06</b> <span style="float: right;">UN. EMP. 2</span></p>  <p><b>PASADOR HOJA RESORTE ISUZU (#8)</b></p> <p style="text-align: center;">∅ 28 mm ↔ 115 mm Engrasador: Chaveta</p>

### HINO

<p><b>COD. 50B-30-01</b> <span style="float: right;">UN. EMP. 2</span></p>  <p><b>PASADOR HOJA RESORTE DEL. HINO FB - Corto</b></p> <p style="text-align: center;">∅ 25mm ↔ 116 mm Engrasador: Chaveta</p>	<p><b>COD. 50B-30-02</b> <span style="float: right;">UN. EMP. 2</span></p>  <p><b>PASADOR HOJA RESORTE DEL. HINO FB - Largo</b></p> <p style="text-align: center;">∅ 25mm ↔ 129 mm Engrasador: Chaveta</p>	<p><b>COD. 50B-30-03</b> <span style="float: right;">UN. EMP. 2</span></p>  <p><b>PASADOR HOJA RESORTE TRAS. HINO FB</b></p> <p style="text-align: center;">∅ 25mm ↔ 118 mm Engrasador: Chaveta</p>
<p><b>COD. 50B-30-04</b> <span style="float: right;">UN. EMP. 2</span> OEM: 54842-32430</p>  <p><b>PASADOR HOJA RESORTE DEL. HINO - Parte delantera</b></p> <p style="text-align: center;">∅ 25mm ↔ 125 mm Engrasador: Chaveta</p>	<p><b>COD. 50B-30-05</b> <span style="float: right;">UN. EMP. 2</span> OEM: 54842-32440</p>  <p><b>PASADOR HOJA RESORTE DEL. HINO - Parte trasera</b></p> <p style="text-align: center;">∅ 25mm ↔ 115 mm Engrasador: Chaveta</p>	<p><b>COD. 50B-30-06</b> <span style="float: right;">UN. EMP. 2</span> OEM 48423-1320</p>  <p><b>PASADOR HOJA RESORTE TRAS. HINO FB500 - Buseton</b></p> <p style="text-align: center;">∅ 30mm ↔ 123 mm Engrasador: Chaveta</p>

### HINO

<p><b>COD. 50B-30-07</b> <span style="float: right;">UN. EMP. 2</span> OEM: 48423-E0240</p>  <p><b>PASADOR HOJA RESORTE HINO 300 / ISUZU</b></p> <p style="text-align: center;">∅ 25mm ↔ 114 mm Engrasador: Chaveta</p>	<p><b>COD. 50B-30-08</b> <span style="float: right;">UN. EMP. 2</span> OEM: 48423-2250</p>  <p><b>PASADOR HOJA RESORTE HINO</b></p> <p style="text-align: center;">∅ 30 mm ↔ 149 mm Engrasador: Chaveta</p>	<p><b>COD. 50B-10-01</b> <span style="float: right;">UN. EMP. 2</span></p>  <p><b>PASADOR HOJA RESORTE HI - Fresado cuadrado</b></p> <p style="text-align: center;">∅ 1" ↔ 157 mm Engrasador: Chaveta</p>
--	--	--

### INTERNATIONAL

<p><b>COD. 50B-10-02</b> <span style="float: right;">UN. EMP. 2</span></p>  <p><b>PASADOR HOJA RESORTE HI</b></p> <p style="text-align: center;">∅ 1" ↔ 156 mm Engrasador: Chave ∅ 1" Chaveta</p>	<p><b>COD. 50B-10-03</b> <span style="float: right;">UN. EMP. 2</span></p>  <p><b>PASADOR HOJA RESORTE INTERNATIONAL</b></p> <p style="text-align: center;">∅ 1 1/4" ↔ 170 mm Engrasador: Chaveta</p>	<p><b>COD. 50B-10-04</b> <span style="float: right;">UN. EMP. 2</span></p>  <p><b>PASADOR HOJA RESORTE TRAS. INTERNATIONAL 4700</b></p> <p style="text-align: center;">∅ 1 1/4" ↔ 143 mm Engrasador: Chaveta</p>
--	--	---

## INTERNATIONAL

<b>COD. 50B-10-05</b>	UN. EMP. 2
	
<b>PASADOR HOJA RESORTE DEL. INTERNATIONAL 4700</b>	
$\varnothing$ 1 1/4" $\leftrightarrow$ 172 mm	
Engrasador: Chaveta	

<b>COD. 50B-10-06</b>	UN. EMP. 2
	
<b>PASADOR HOJA RESORTE INTERNATIONAL (#3)</b>	
$\varnothing$ 1 1/4" $\leftrightarrow$ 172 mm	
Engrasador: Chaveta	

## MERCEDES BENZ

<b>COD. 50B-17-01</b>	UN. EMP. 2
OEM 3523250530	
	
<b>PASADOR HOJA RESORTE TRAS. MERCEDES BENZ (#4) 1116 / 1316 / 1719</b>	
$\varnothing$ 1 1/4" $\varnothing$ 30 mm $\leftrightarrow$ 139 mm	
Engrasador: Chaveta	

## MERCEDES BENZ

<b>COD. 50B-17-02</b>	UN. EMP. 2
	
<b>PASADOR HOJA RESORTE DEL. MERCEDES BENZ (#5) 1116 / 1316 / 1719</b>	
$\varnothing$ 1 1/4" $\varnothing$ 25 mm $\leftrightarrow$ 131 mm	
Engrasador: Chaveta	

## MITSUBISHI

<b>COD. 50B-18-01</b>	UN. EMP. 2
OEM 3523250530	
	
<b>PASADOR HOJA RESORTE TRAS. CANTER</b>	
$\varnothing$ 28 mm $\leftrightarrow$ 136 mm	
Engrasador: Chaveta	

<b>COD. 50B-18-02</b>	UN. EMP. 2
	
<b>PASADOR HOJA RESORTE DEL. CANTER</b>	
$\varnothing$ 28 mm $\leftrightarrow$ 130 mm	
Engrasador: Chaveta	

## NISSAN

<b>COD. 50B-20-01</b>	UN. EMP. 2
	
<b>PASADOR HOJA RESORTE TRAS. NISSAN UD</b>	
$\varnothing$ 1 1/4" $\varnothing$ 28 mm $\leftrightarrow$ 119 mm	
Engrasador : Chaveta	

<b>COD. 50B-20-02</b>	UN. EMP. 2
	
<b>PASADOR HOJA RESORTE DEL. NISSAN UD</b>	
$\varnothing$ 1 1/4" $\varnothing$ 28 mm $\leftrightarrow$ 119 mm	
Engrasador : Chaveta	

<b>COD. 50B-20-03</b>	UN. EMP. 2
	
<b>PASADOR HOJA RESORTE NISSAN UD 30mm</b>	
$\varnothing$ 30mm $\leftrightarrow$ 141 mm	
Engrasador : Chaveta	

## UNIVERSALES

<b>COD. 50B-00-01</b>	UN. EMP. 2
	
<b>PASADOR HOJA RESORTE UNIVERSAL - 119F</b>	
$\varnothing$ 25mm $\leftrightarrow$ 128mm	
Engrasador: Chaveta	

<b>COD. 50B-00-02</b>	UN. EMP. 2
	
<b>PASADOR HOJA RESORTE UNIVERSAL - 121</b>	
$\varnothing$ 1 1/8" $\leftrightarrow$ 130mm	
Engrasador: Chaveta	

<b>COD. 50B-00-03</b>	UN. EMP. 2
	
<b>PASADOR HOJA RESORTE UNIVERSAL - 122</b>	
$\varnothing$ 1 1/8" $\leftrightarrow$ 130mm	
Engrasador: Chaveta	

<b>COD. 50B-00-04</b>	UN. EMP. 2
REF. 29F01-02252-10364	
	
<b>PASADOR HOJA RESORTE UNIVERSAL</b>	
$\varnothing$ 13/8" $\leftrightarrow$ 174mm	
Engrasador: Chaveta	

<b>COD. 50B-00-05</b>	UN. EMP. 2
REF. 29F01-02252	
	
<b>PASADOR HOJA RESORTE UNIVERSAL</b>	
$\varnothing$ 1 1/4" $\leftrightarrow$ 150mm	
Engrasador: Chaveta	

<b>COD. 50B-00-06</b>	UN. EMP. 2
	
<b>PASADOR HOJA RESORTE FREIGHTLINER</b>	
$\varnothing$ 1 1/4" $\leftrightarrow$ 175 mm	
Engrasador: Chaveta	

**CHEVROLET**

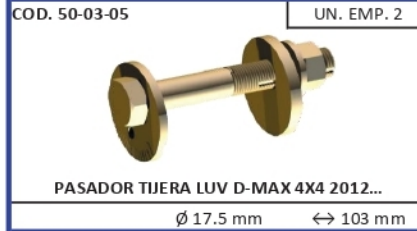
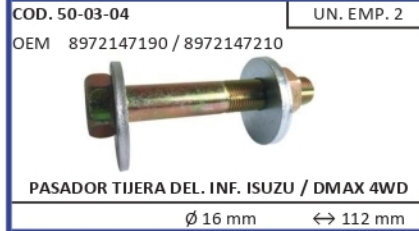

**CHEVROLET**



**DAIHATSU**

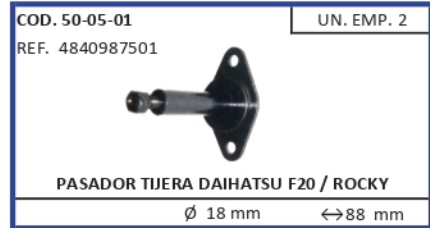

**DAIHATSU**

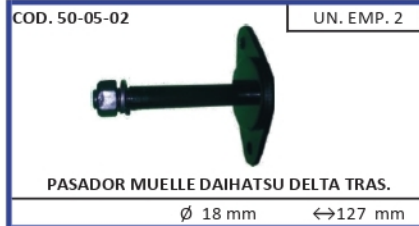

**FORD**

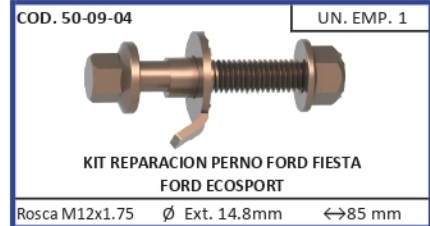
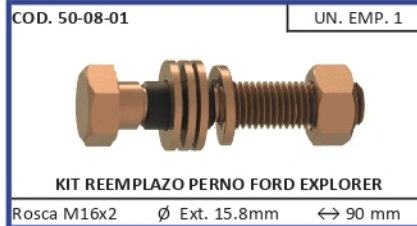

**HONDA**

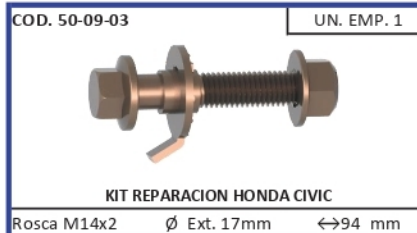
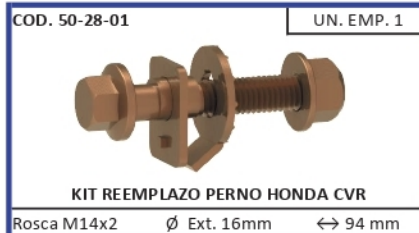

**HYUNDAI**

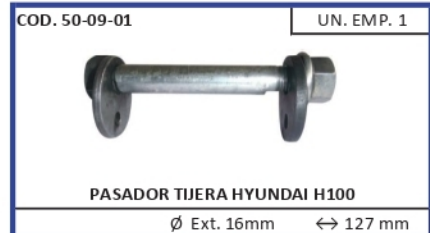

**HYUNDAI**

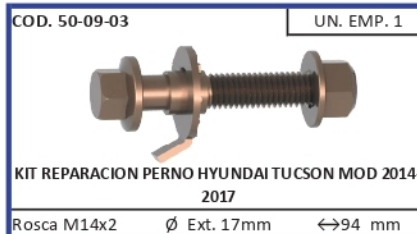
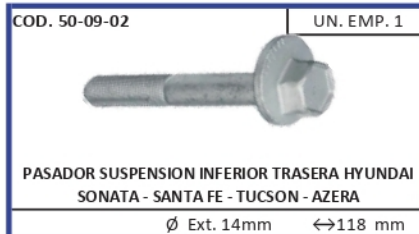

**HYUNDAI**

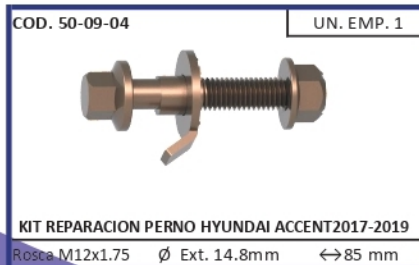

**KIA**



## KIA

COD. 50-12-03

UN. EMP. 1



PASADOR SUSPENSION INFERIOR TRASERA KIA SORENTO - OPTIMA - SEDONA - CADENZA - SPORTAGE

∅ Ext. 14mm ↔ 118 mm

COD. 50-09-03

UN. EMP. 1

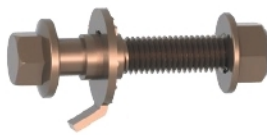

KIT REPARACION PERNO KIA RIO

Rosca M14x2 ∅ Ext. 17mm ↔ 94 mm

COD. 50-16-01

UN. EMP. 2



PASADOR TIJERA MAZDA B2000 - B2200

∅ 17 mm ↔ 106.5 mm

## MAZDA

COD. 50-16-02

UN. EMP. 2



PASADOR TIJERA MAZDA B2600

∅ 17 mm ↔ 106.5 mm

COD. 50-18-01

UN. EMP. 2



PASADOR TIJERA INF. L-300 VAN

∅ 16 mm ↔ 122mm

COD. 50-18-02

UN. EMP. 2



PASADOR MUELLE TRAS. CANTER / H100

∅ 22 mm ↔ 131mm

## MAZDA

COD. 50-18-03

UN. EMP. 2



PIN TIJERA TRAS. MONTERO

∅ 18 mm ↔ 119mm

COD. 50-20-01

UN. EMP. 2



PASADOR TIJERA NISSAN D21

∅ Ext. 18 mm ↔ 109 mm

COD. 50A-20-01

UN. EMP. 2



PASADOR TIJERA INF. NISSAN D21 (86) - Tuerca

∅Ext. 18 mm ↔ 133 mm

## NISSAN

## NISSAN

COD. 50-20-02

UN. EMP. 2

REF. 54582540A



PASADOR TIJERA  
FRONTIER 4WD - D22 Cabina y Chasis corto.

∅Ext. 14 mm ↔ 106mm

COD. 50A-20-02

UN. EMP. 2

REF. 54419VK80A



PASADOR TIJERA  
NISSAN D22 2WD / FRONTIER (98) - Tuerca

∅Ext. 18 mm ↔ 125 mm

COD. 50-20-03

UN. EMP. 2



PASADOR TIJERA  
NISSAN NAVARA

∅Ext. 14 mm ↔ 132 mm

COD. 50-24-04

UN. EMP. 2

REF. 4819035020



PASADOR TIJERA DEL. HILUX / T100  
4RUNNER 4WD - 2WD (86-95)

∅ 16 mm ↔ 128.5 mm

COD. 50-24-06

UN. EMP. 2



PASADOR TIJERA DEL. INF. TACOMA /  
4 RUNNER (96-04)

∅ 18.3 mm ↔ 142 mm

COD. 50-24-07

UN. EMP. 2



PASADOR MUELLE TRAS. PARTE DELANTERA  
HILUX LN106 / RN105

∅ 18 mm ↔ 106 mm

COD. 50-24-11

UN. EMP. 2



PASADOR TIJERA DEL. HIACE (04-12)

∅ 14 mm ↔ 140 mm

COD. 50-24-12

UN. EMP. 2



PASADOR TIJERA TOYOTA PRADO TX INFERIOR

∅ 15 mm ↔ 155mm

COD. 50-24-13

UN. EMP. 2



PASADOR TIJERA TOYOTA PRADO TX SUPERIOR

∅ 19 mm ↔ 140mm

**COD. 50-24-10** UN. EMP. 2  
 REF. 48190-60020

**PASADOR TIJERA SUP. LARGO TACOMA (04) / 4RUNNER (02-09) / LAND CRUISER PRADO (02)**

∅ 14 mm ↔ 160 mm

**COD. 50-24-09** UN. EMP. 2  
 REF. 48190-0K010

**PASADOR TIJERA BAJO VIGO 4WD Corto**

∅ 14 mm ↔ 132 mm

**COD. 50-24-14** UN. EMP. 2  
 REF. K100128

**PASADOR TIJERA BAJO VIGO 4WD Corto**

PSD. TJR. TACOMA - 4 RUNNER - LEXUS - FJ CRUISER 2WD

∅ A 14 mm ∅ B 16.8 mm / ↔ A 140 mm B 168 mm

**COD. 50-24-15** UN. EMP. 2  
 REF.

**KIT DE PERNO #25445 TOYOTA TUNDRA**

∅ A 16mm ∅ B 16mm / ↔ A 140mm B 120mm

**COD. 50-24-16** UN. EMP. 2  
 REF.

**KIT REEMPLAZO PERNO TOYOTA RAV**

Rosca M14x2 ∅ 16 mm ↔ 94 mm

**COD. 50A-24-01** UN. EMP. 2  
 REF. 90114-18003

**PASADOR TIJERA DEL INF. 4RUNNER - PICKUP (84-95) / T100 (93-98) Con tuerca**

∅ 18 mm ↔ 133 mm

**COD. 50A-24-02** UN. EMP. 2  
 REF. 90114-18001

**PASADOR TIJERA DEL INF. PICKUP (79-83) Con tuerca**

∅ 18 mm ↔ 133 mm

## PASADORES DE MUELLE

### TOYOTA

**COD. 50-24-01** UN. EMP. 2  
 REF. 448435010

**PASADOR MUELLE DEL. TRAS. LAND CRUISER FJ55 (69-77)**

∅ 14.5mm ↔ 116 mm

**COD. 50-24-02** UN. EMP. 2

**PASADOR MUELLE TRAS. LAND CRUISER (85-87)**

∅ 18 mm ↔ 124 mm

**COD. 50-24-03** UN. EMP. 2

**PASADOR MUELLE (82-95)**

∅ 18 mm ↔ 124.5 mm

**COD. 50-24-05** UN. EMP. 2

**PASADOR MUELLE LAND CRUISER BASE 4.5**

∅ 18 mm ↔ 123 mm

**COD. 50-24-08** UN. EMP. 2  
 REF. 0448435011

**PASADOR MUELLE TRAS. LAND CRUISER FJ45 GAS / HJ45 DIESEL / BJ43 DIESEL**

∅ 18 mm ↔ 123 mm

### UNIVERSALES

UN. EMP. 10	COD.	DESCRIPCION	↔	∅A	∅B
	51-00-01	PASADOR RACHE CORTO	40 mm	16 mm	12.5 mm
	51-00-02	PASADOR RACHE LARGO	51 mm	16 mm	12.5 mm

UN. EMP. 2	COD.	DESCRIPCION	↔	∅	Rca. Ext.
	52-00-01	PASADOR ZAPATA FRENO U - Corta	95 mm	32 mm	7/8" x14H
	52-00-02	PASADOR ZAPATA FRENO U - Larga	109 mm	32 mm	7/8" x14H
	52-00-03	PASADOR ZAPATA FRENO U - ExtraLarga	113 mm	32 mm	7/8" x14H

RODAMIENTOS

PRODUCTO	CODIGO	CODIGO ASAM	DESCRIPCION	
	<b>6205-2RS</b> (25x52x15)	<b>61-16-05</b>	MAZDA 1600 -2000 / FORD CURRIER	
		<b>61-03-29</b>		
		<b>61-03-35</b>	ISUZU TROOPER 2300 (83-87)	
	<b>6206-2RS</b> (30x62x16)	<b>61-16-04</b>		MAZDA B200 -2200
		<b>61-03-28</b>		
		<b>61-16-02</b>		ISUZU NPR (03...)
		<b>61-03-30</b>		
		<b>61-16-03</b>		TOYOTA HILUX 4WD - RODAMIENTO KBC
		<b>61-03-31</b>		
		<b>61-03-32</b>		LUV 2300 4WD / ISUZU KB 2.3
		<b>61-20-06</b>		NISSAN PICK UP D21 2WD / DATSUN 2WD
		<b>61-03-33</b>		
		<b>61-20-07</b>		NISSAN PICK UP D21 4WD / DATSUN 4WD
		<b>61-03-34</b>		
		<b>61-03-36</b>		ISUZU TROOPER 2600 (88...)
		<b>61-19-03</b>		MITSUBISHI L200 - K14
		<b>61-03-37</b>		
		<b>61-24-04</b>		TOYOTA HILUX 2WD (99-02)
		<b>61-03-38</b>		
		<b>61-24-05</b>		TOYOTA DYNA
		<b>61-03-44</b>		
	<b>61-24-06</b>		TOYOTA COASTER	
	<b>61-03-45</b>			
	<b>61-03-47</b>		CHEVROLET LUV DMAX 2WD	
	<b>61-03-48</b>		CHEVROLET LUV DMAX 4WD	
	<b>61-03-49</b>		CHEVROLET LUV DMAX 2WD DIESEL CS 2.5 TD	
	<b>61-03-50</b>		CHEVROLET LUV 2300 2DW	
	<b>61-08-01</b>		FORD RANGER (98-06)	
	<b>61-09-01</b>		HYUNDAI GRACE / H100	
	<b>61-16-01</b>		MAZDA B2600 (PO65 25-310)	
	<b>61-20-01</b>		DATSUN PICK UP Z50 (79-86)	
	<b>61-20-03</b>		NISSAN D22 4WD / FRONTIER (06...)	
	<b>6207-2RS</b> (35x72x17)	<b>61-05-01</b>		DAHIATSU DELTA
<b>6208-2RS</b> (40x80x18)	<b>61-03-27TO</b>		CHEVROLET ISUZU NPR - Tipo Original	
	<b>61-03-27CO</b>		NPR-NKR (98-03) - Completo	
	<b>61-19-01</b>		MITSUBISHI CANTER	
	<b>61-20-05</b>		NISSAN UD41	
	<b>61-32-01</b>		JAC TODOS	
<b>6209-2RS</b> (45x85x19)	<b>61-03-46</b>		ISUZU FORWARD / ENCAVA	
	<b>61-30-01</b>		HINO FD TURBO	
<b>62/28-2RS</b> (28x58x16)	<b>61-12-01</b>		KIA SPORTAGE	
<b>88507-2RS</b> (35x72x17)	<b>61-03-16</b>		CHEVROLET C30	
<b>88508-2RS</b> (40x80x21)	<b>61-03-17</b>		CHEVROLET F600 - 800 (67) / PIRAGUA / OTROS	
<b>88508A-2RS</b> (40x72x17)	<b>61-03-27</b>		CHEVROLET ISUZU NPR - Tipo Spicer	
	<b>61-03-27N</b>		CHEVROLET ISUZU NPR (03...)	
	<b>61-20-02</b>		NISSAN D21 - Mexicano	
<b>88509-2RS</b> (45x85x21)	<b>61-03-18</b>		MACK / OTROS	
<b>88510-2RS</b> (50x90x22)	<b>61-03-19</b>		CHEVROLET F950 - 1000	
<b>88512-2RS</b> (60x110x22)	<b>61-00-02</b>		F900 / SUPER BRIGADIER / MACK	
	<b>61-03-20</b>		TROQUE BRIGADIER / OTROS	
<b>6006-2RS</b> (30x55x13)	<b>61-08-02</b>		FORD ECOSPORT	
<b>6009-2RS</b> (45x75x16)	<b>61-20-04</b>		NISSAN CABSTAR (05-08)	
<b>6307-2RS</b> (35x80x21)	<b>61-19-04</b>		MITSUBISHI CANTER (00-04)	

\* Código púrpura es el código antiguo

**CHEVROLET- ISUZU**

<p><b>COD. 61-03-32</b> UN. EMP. 1 OEM 8-94328-799-0</p>  <p style="text-align: center;"><b>SOPORTE CARDAN ISUZU TROOPER 4WD 2.3-2.6-2.8 (88...)/ LUV 2300 4WD</b></p> <p>RODAMIENTO : 6206-2RS ∅ 30 Int.    ∓ 62 mm    ↔ 16 mm</p>	<p><b>COD. 61-03-35</b> UN. EMP. 1 OEM 8-94222-970-0</p>  <p style="text-align: center;"><b>SOPORTE CARDAN DEL. ISUZU TROOPER 2.3 (83-87)/LUV 1600</b></p> <p>RODAMIENTO: 6205-2RS ∅ 25 Int.    ∓ 52 mm    ↔ 15 mm</p>	<p><b>COD. 61-03-36</b> UN. EMP. 1 OEM 8-3438-799-0</p>  <p style="text-align: center;"><b>SOPORTE CARDAN ISUZU TROOPER 2.6 / RODEO TFR TFS 4WD</b></p> <p>RODAMIENTO : 6206-2RS ∅ 30 Int.    ∓ 62 mm    ↔ 16 mm</p>
<p><b>COD. 61-03-46</b> UN. EMP. 1 OEM 1-37510-105-0 / GM 94057151</p>  <p style="text-align: center;"><b>SOPORTE CARDAN ISUZU FORWARD / ENCAVA / FVR</b></p> <p>RODAMIENTO : 6209-2RS ∅ 45 Int.    ∓ 85 mm    ↔ 19 mm</p>	<p><b>COD. 61-03-47</b> UN. EMP. 1 OEM 8-97942-876-0</p>  <p style="text-align: center;"><b>SOPORTE CARDAN ISUZU DMAX 2WD/LUV</b></p> <p>RODAMIENTO : 6206-2RS ∅ 30 Int.    ∓ 62 mm    ↔ 16 mm</p>	<p><b>COD. 61-03-48</b> UN. EMP. 1 OEM 8-97942-877-0</p>  <p style="text-align: center;"><b>SOPORTE CARDAN DEL. DMAX 3.0-3.5 4WD/LUV</b></p> <p>RODAMIENTO: 6206-2RS ∅ 30 Int.    ∓ 62 mm    ↔ 16 mm</p>
<p><b>COD. 61-03-49</b> UN. EMP. 1 OEM 8-97942-876-0</p>  <p style="text-align: center;"><b>SOPORTE CARDAN ISUZU DMAX 2WD 2.4 -2.5</b></p> <p>RODAMIENTO : 6206-2RS ∅ 30 Int.    ∓ 62 mm    ↔ 16 mm</p>	<p><b>COD. 61-03-50</b> UN. EMP. 1 OEM 8-97942-876-0</p>  <p style="text-align: center;"><b>SOPORTE CARDAN ISUZU LUV 2300 2WD</b></p> <p>RODAMIENTO : 6206-2RS ∅ 30 Int.    ∓ 62 mm    ↔ 16 mm</p>	<p><b>COD. 61-03-51</b> UN. EMP. 1 OEM SA02 25 310</p>  <p style="text-align: center;"><b>SOPORTE CARDAN LUV / DMAX 3.0 4WD (05...)</b></p> <p>RODAMIENTO: 62/28-2RS ∅ 28 Int.    ∓ 58 mm    ↔ 16 mm</p>
<p><b>COD. 61-03-52</b> UN. EMP. 1 REF. 96624772</p>  <p style="text-align: center;"><b>SOPORTE CARDAN CHEVROLET CAPTIVA</b></p> <p>RODAMIENTO : 6006-2RS ∅ Int. 30 mm    ∓ 55 mm    ↔ 13 mm</p>	<p><b>COD. 61-03-53</b> UN. EMP. 1 OEM: 8-97947656-0</p>  <p style="text-align: center;"><b>SOPORTE CARDAN LUV D-MAX RT-50 4X2 2015-2018</b></p> <p>RODAMIENTO : 6206-2RS ∅ 30 Int.    ∓ 62 mm    ↔ 16 mm</p>	<p><b>COD. 61-03-54</b> UN. EMP. 1 OEM: 8-97947660-0</p>  <p style="text-align: center;"><b>SOPORTE CARDAN LUV D-MAX RT-50 4X4 2015-2018</b></p> <p>RODAMIENTO : 6206-2RS ∅ 30 Int.    ∓ 62 mm    ↔ 16 mm</p>
<p><b>COD. 64-03-01</b> UN. EMP.5</p>  <p style="text-align: center;"><b>TAPA BALINERA CARDAN LUV 2300</b></p> <p>∅ Int. 48 mm    ∅ Ext. 64 mm    ↔ 15 mm</p>		

COD. 61-03-27TO UN. EMP. 1  
REF. 5-37510-007



**SOPORTE CARDAN NPR-NKR (98-03) Tipo original**

RODAMIENTO : 6208-2RS  
 Ø 40 Int.    ⬆ 80 mm    ↔ 18 mm

COD. 61-32-01 UN. EMP. 1



**SOPORTE CARDAN JAC CAMION**

Ø 40 Int.    ⬆ 142 mm    ↔ 192 mm

COD. 61-32-02 UN. EMP. 1



**SOPORTE CARDAN JAC CAMION MOD. 2003 EN ADELANTE**



Ø 40 Int.    ⬆ 142 mm    ↔ 188 mm

COD. 61-03-27CO UN. EMP. 1



**SOPORTE CARDAN ISUZU/NPR/NKR 98-2003**

Ø 40 Int.    ⬆ 132 mm    ↔ 191 mm

			SOPORTE CARDAN NPR - NKR		
			COD.	REF.	DESCRIPCION
			61-03-27	5375100070	SOPORTE CARDAN NPR. (MV)
<b>SOPORTE CARDAN NPR - NKR</b>			61-03-27CO	5-37510-007	KIT COMPLETO CON U - ISUZU NPR-NKR (98-03)
RODAMIENTO : 6208-2RS Ø 40 mm    ⬆ 80 mm    ↔ 18 mm			61-03-27N	112-902010T-X	SOPORTE CARDAN ISUZU NPR (06...) TIPO SPICER
UN. EMP. 1					

## DAHIATSU

COD. 61-05-01 UN. EMP. 1  
REF. 37208-87302-000



**SOPORTE CARDAN DELTA V12 - V22 - V32**

RODAMIENTO : 6207-2RS  
 Ø Int. 35 mm    ⬆ 72 mm    ↔ 17 mm

COD. 61-05-02 UN. EMP. 1



**SOPORTE CARDAN JEEP DAHIATSU / TERIOS - ZOYTE / NOMADA CHINO**

RODAMIENTO : 6206-2RS  
 Ø Int. 30 mm    ⬆ 62 mm    ↔ 16 mm

COD. 61-05-03 UN. EMP. 1  
REF. 37100-87402



**SOPORTE DE CARDAN DAHIATSU TERIOS (MN)**

RODAMIENTO : 6205-2RS  
 Ø Int. 25 mm    ⬆ 52 mm    ↔ 15 mm

## DAHIATSU

## JAC

COD. 61-05-04 UN. EMP. 1  
REF.



**SOPORTE DE CARDAN DAHIATSU TERIOS OKII**

RODAMIENTO : 6205-2RS  
 Ø Int. 25 mm    ⬆ 52 mm    ↔ 15 mm

COD. 61-32-01 UN. EMP. 1  
OEM 5-37510-007



**SOPORTE CARDAN JAC - Camion**

RODAMIENTO : 6208-2RS  
 Ø 40 Int.    ⬆ 80 mm    ↔ 18 mm

COD. 61-32-02 UN. EMP. 1  
OEM 5-37510-007



**SOPORTE CARDAN JAC (MN 03...) - 2 huecos**

RODAMIENTO : 6208-2RS  
 Ø 40 Int.    ⬆ 80 mm    ↔ 18 mm

**FORD**

**JMC**



<b>COD. 61-08-01</b>	UN. EMP. 1
REF. HHBD206FF	
	
<b>KIT SOPORTE CARDAN FORD RANGER (98-06)</b>	
RODAMIENTO : 6206-2RS	
∅ 30 Int.    ⇅ 62 mm    ⇔ 16 mm	

<b>COD. 61-08-02</b>	UN. EMP. 1
	
<b>KIT SOPORTE CARDAN ECOSPORT</b>	
RODAMIENTO : 6006-2RS	
∅ 30 Int.    ⇅ 55 mm    ⇔ 13 mm	

<b>COD. 61-33-01</b>	UN. EMP. 1
	
<b>SOPORTE DE CARDAN JMC</b>	
RODAMIENTO : 62/32-2RS	
∅ 32 Int.    ⇅ 142 mm    ⇔ 191 mm	

UN. EMP. 1	<b>SOPORTE CARDAN F350-600 / D300-600 / CHEVROLET C30</b> Sistema Nuevo																			
																				
<b>SOPORTE CARDAN F350-600 / D300-600 / CHEVROLET C30 (SN)</b>																				
RODAMIENTO: 88107																				
∅ 35 mm    ⇅ 72 mm    ⇔ 17 mm		R360																		
	<table border="1" style="width: 100%; border-collapse: collapse;"> <thead> <tr> <th style="width: 15%;">COD.</th> <th style="width: 15%;">REF.</th> <th style="width: 70%;">DESCRIPCION</th> </tr> </thead> <tbody> <tr> <td>61-03-10</td> <td>B5T-4808</td> <td>LATA</td> </tr> <tr> <td>61-03-03</td> <td>B5T-4808</td> <td>LATA + U</td> </tr> <tr> <td>64-08-01</td> <td></td> <td>TAPA BALINERA CARDAN (JUEGO)</td> </tr> <tr> <td>61-03-16</td> <td>B5T-4808</td> <td>SOPORTE COMPLETO - Caucho Negro</td> </tr> <tr> <td>61-03-16C</td> <td>B5T-4808</td> <td>CAUCHO NEGRO</td> </tr> </tbody> </table>	COD.	REF.	DESCRIPCION	61-03-10	B5T-4808	LATA	61-03-03	B5T-4808	LATA + U	64-08-01		TAPA BALINERA CARDAN (JUEGO)	61-03-16	B5T-4808	SOPORTE COMPLETO - Caucho Negro	61-03-16C	B5T-4808	CAUCHO NEGRO	
COD.	REF.	DESCRIPCION																		
61-03-10	B5T-4808	LATA																		
61-03-03	B5T-4808	LATA + U																		
64-08-01		TAPA BALINERA CARDAN (JUEGO)																		
61-03-16	B5T-4808	SOPORTE COMPLETO - Caucho Negro																		
61-03-16C	B5T-4808	CAUCHO NEGRO																		

UN. EMP. 1	<b>SOPORTE CARDAN B60 C70 / HI / F600-800 / PIRAGUA / OTROS</b>																			
																				
<b>SOPORTE CARDAN B60 C70 / HI / F600-800 / PIRAGUA / OTROS</b>																				
RODAMIENTO: 88508																				
∅ 40 mm    ⇅ 80 mm    ⇔ 21 mm		R361																		
	<table border="1" style="width: 100%; border-collapse: collapse;"> <thead> <tr> <th style="width: 15%;">COD.</th> <th style="width: 15%;">REF.</th> <th style="width: 70%;">DESCRIPCION</th> </tr> </thead> <tbody> <tr> <td>61-03-01</td> <td>B5QH-4808</td> <td>LATA + U - Sistema Viejo</td> </tr> <tr> <td>61-03-05</td> <td>B5QH-4808</td> <td>LATA + U - Sistema nuevo</td> </tr> <tr> <td>64-08-02</td> <td></td> <td>TAPA BALINERA CARDAN (JUEGO)</td> </tr> <tr> <td>61-03-17</td> <td>B5QH-4808</td> <td>SOPORTE COMPLETO - Caucho Negro</td> </tr> <tr> <td>61-03-17C</td> <td>B5QH-4808</td> <td>CAUCHO NEGRO</td> </tr> </tbody> </table>	COD.	REF.	DESCRIPCION	61-03-01	B5QH-4808	LATA + U - Sistema Viejo	61-03-05	B5QH-4808	LATA + U - Sistema nuevo	64-08-02		TAPA BALINERA CARDAN (JUEGO)	61-03-17	B5QH-4808	SOPORTE COMPLETO - Caucho Negro	61-03-17C	B5QH-4808	CAUCHO NEGRO	
COD.	REF.	DESCRIPCION																		
61-03-01	B5QH-4808	LATA + U - Sistema Viejo																		
61-03-05	B5QH-4808	LATA + U - Sistema nuevo																		
64-08-02		TAPA BALINERA CARDAN (JUEGO)																		
61-03-17	B5QH-4808	SOPORTE COMPLETO - Caucho Negro																		
61-03-17C	B5QH-4808	CAUCHO NEGRO																		

UN. EMP. 1	<b>SOPORTE CARDAN F900 / MACK / OTROS</b>																						
																							
<b>SOPORTE CARDAN F900 / MACK / OTROS</b>																							
RODAMIENTO: 88509																							
∅ 45 mm    ⇅ 85 mm    ⇔ 21 mm		R362																					
	<table border="1" style="width: 100%; border-collapse: collapse;"> <thead> <tr> <th style="width: 15%;">COD.</th> <th style="width: 15%;">REF.</th> <th style="width: 70%;">DESCRIPCION</th> </tr> </thead> <tbody> <tr> <td>61-03-12</td> <td>B9TT-4808</td> <td>LATA</td> </tr> <tr> <td>61-03-06</td> <td>B9TT-4808</td> <td>LATA + U</td> </tr> <tr> <td>61-03-07</td> <td>B9TT-4808</td> <td>LATA + U - Sistema Nuevo</td> </tr> <tr> <td>64-08-03</td> <td>TBC3 B9TT4</td> <td>TAPA BALINERA CARDAN (JUEGO)</td> </tr> <tr> <td>61-03-18</td> <td>B9TT-4808</td> <td>SOPORTE COMPLETO - Caucho negro</td> </tr> <tr> <td>61-03-18C</td> <td>B9TT-4808</td> <td>CAUCHO NEGRO</td> </tr> </tbody> </table>	COD.	REF.	DESCRIPCION	61-03-12	B9TT-4808	LATA	61-03-06	B9TT-4808	LATA + U	61-03-07	B9TT-4808	LATA + U - Sistema Nuevo	64-08-03	TBC3 B9TT4	TAPA BALINERA CARDAN (JUEGO)	61-03-18	B9TT-4808	SOPORTE COMPLETO - Caucho negro	61-03-18C	B9TT-4808	CAUCHO NEGRO	
COD.	REF.	DESCRIPCION																					
61-03-12	B9TT-4808	LATA																					
61-03-06	B9TT-4808	LATA + U																					
61-03-07	B9TT-4808	LATA + U - Sistema Nuevo																					
64-08-03	TBC3 B9TT4	TAPA BALINERA CARDAN (JUEGO)																					
61-03-18	B9TT-4808	SOPORTE COMPLETO - Caucho negro																					
61-03-18C	B9TT-4808	CAUCHO NEGRO																					

 <p><b>SOPORTE CARDAN SUPER BRIGADIER / FORD / MACK 900</b></p> <p>RODAMIENTO: 88512  <math>\varnothing</math> 60 mm    <math>\updownarrow</math> 110 mm    <math>\leftrightarrow</math> 22 mm</p>	UN. EMP. 1	<b>SOPORTE CARDAN SUPER BRIGADIER / BRIGADIER / F900 / MACK / OTROS</b>		
		<b>COD.</b>	<b>REF.</b>	<b>DESCRIPCION</b>
	61-00-03	35MU32F3	LATA + U	
	61-03-02		LATA + U - BRIGADIER / DTROQUE	
	61-00-02		SOPORTE COMPLETO - CAUCHO NEGRO	
	64-08-04		TAPA BALINERA JUEGO	

 <p><b>SOPORTE CARDAN F950 - 1000</b></p> <p>RODAMIENTO: 88510  <math>\varnothing</math> 50 mm    <math>\updownarrow</math> 90 mm    <math>\leftrightarrow</math> 22 mm</p>	UN. EMP. 1	<b>SOPORTE CARDAN F950 - 1000</b>		
		<b>COD.</b>	<b>REF.</b>	<b>DESCRIPCION</b>
	61-03-08	B9TT-335	LATA + U	
	61-03-13	B9TT-335	LATA	
	64-08-05		TAPA BALINERA DE CARDAN	
	61-03-19	B9TT-335	SOPORTE COMPLETO - CAUCHO NEGRO	
	61-03-19C	B9TT-335	CAUCHO NEGRO	

 <p><b>SOPORTE CARDAN DOBLE TROQUE BRIGADIER Y OTROS</b></p> <p>RODAMIENTO: 88512  <math>\varnothing</math> 60 mm    <math>\updownarrow</math> 110 mm    <math>\leftrightarrow</math> 22 mm</p>	UN. EMP. 1	<b>SOPORTE CARDAN DOBLE TROQUE BRIGADIER Y OTROS</b>		
		<b>COD.</b>	<b>REF.</b>	<b>DESCRIPCION</b>
	61-03-02		LATA + U	
	61-03-09		LATA	
	64-08-04		TAPA BALINERA DE CARDAN	
	61-03-20		SOPORTE COMPLETO - CAUCHO NEGRO	
	61-03-20C		CAUCHO NEGRO	

## HINO

## HYUNDAI / KIA

<b>COD. 61-30-01</b>	UN. EMP. 1
OEM 37235-1200 / 1210	
	
<b>SOPORTE CARDAN HINO FD TURBO / FC4J / SUPERDELTA</b>	
RODAMIENTO : 6209-2RS	
$\varnothing$ 45 Int. $\updownarrow$ 85 mm $\leftrightarrow$ 19 mm	

<b>COD. 61-09-01</b>	UN. EMP. 1
OEM 49130A-4A000	
	
<b>SOPORTE CARDAN STAREX H100/GRAND STAREX</b>	
RODAMIENTO : 6206-2RS	
$\varnothing$ 30 Int. $\updownarrow$ 62 mm $\leftrightarrow$ 16 mm	

<b>COD. 61-12-01</b>	UN. EMP. 1
OEM 0K02F-25310	
	
<b>SOPORTE CARDAN SPORTAGE 2WD (95-02)</b>	
RODAMIENTO : 62/28-2RS	
$\varnothing$ 28 Int. $\updownarrow$ 58 mm $\leftrightarrow$ 16 mm	

**HYUNDAI / KIA**

<b>COD. 61-12-02</b>	UN. EMP. 1
	
<b>SOPORTE CARDAN KIA SORENTO MOD. 2003 - 2006/49100-3E450</b>	
∅ 28 Int.    ↓ 117 mm    ↔ 216 mm	

<b>COD. 61-16-01</b>	UN. EMP. 1
OEM P065-25-310	
	
<b>SOPORTE CARDAN MAZDA B2600 4WD</b>	
RODAMIENTO : 6206-2RS	
∅ 30 Int.    ↓ 62 mm    ↔ 16 mm	

<b>COD. 61-16-02</b>	UN. EMP. 1
OEM P030-25-310	
	
<b>SOPORTE CARDAN MAZDA B2000 (88-89) / B2200 (82-92) / B2600 (87-92)</b>	
RODAMIENTO : 6205-2RS	
∅ 25 Int.    ↓ 52 mm    ↔ 15 mm	

<b>COD. 61-16-03</b>	UN. EMP. 1
OEM P065-25-310	
	
<b>SOPORTE CARDAN MAZDA B3000</b>	
RODAMIENTO : 62/28-2RS	
∅ 28 Int.    ↓ 58 mm    ↔ 16 mm	

<b>COD. 61-16-04</b>	UN. EMP. 1
OEM P047-25-310	
	
<b>SOPORTE CARDAN MAZDA B2000 / B2200 (90-06)</b>	
RODAMIENTO : 6206-2RS	
∅ 30 Int.    ↓ 62 mm    ↔ 16 mm	

<b>COD. 61-16-05</b>	UN. EMP. 1
OEM 0755-25-300	
	
<b>SOPORTE CARDAN MAZDA B1600 / FORD CURRIER</b>	
RODAMIENTO : 6205-2RS	
∅ 25 Int.    ↓ 52 mm    ↔ 15 mm	

**MAZDA**

<b>COD. 61-16-06</b>	UN. EMP. 1
OEM P027-25-310	
	
<b>SOPORTE CARDAN MAZDA B2600 INY / BT50</b>	
RODAMIENTO : 62/28-2RS	
∅ 28 Int.    ↓ 58 mm    ↔ 16 mm	

<b>COD. 61-19-01</b>	UN. EMP. 1
OEM 47105A620	
	
<b>SOPORTE CARDAN CANTER(MV)- Buseta-Camion HYUNDAI COUNTY HD72 - Con aceitera</b>	
RODAMIENTO : 6208-2RS	
∅ 40 Int.    ↓ 80 mm    ↔ 18 mm	

<b>COD. 61-19-02</b>	UN. EMP. 1
OEM MB000076 / MB000083	
	
<b>SOPORTE CARDAN CANTER ROSA MOD. 2004 EN ADEL.</b>	
RODAMIENTO : 6208-2RS	
∅ 40 Int.    ↓ 80 mm    ↔ 18 mm	

<b>COD. 61-19-03</b>	UN. EMP. 1
REF. MB154080	
	
<b>SOPORTE CARDAN MITSUBISHI L200-K14 / LANCER A161 / LAZOR (83-91) / DODGE D50 (79-82) / RAM 50 (83-89)</b>	
RODAMIENTO : 6206-2RS	
∅ 30 Int.    ↓ 62 mm    ↔ 16 mm	

<b>COD. 61-19-04</b>	UN. EMP. 1
	
<b>SOPORTE CARDAN CANTER (00-04)</b>	
RODAMIENTO : 6307-2RS	
∅ 35 Int.    ↓ 80 mm    ↔ 21 mm	

<b>COD. 61-19-05</b>	UN. EMP. 1
	
<b>SOPORTE CARDAN CANTER ROSA MOD. 91</b>	
RODAMIENTO : 6307-2RS	
∅ 40 Int.    ↓ 152 mm    ↔ 212 mm	

## NISSAN

<b>COD. 61-20-03</b>	UN. EMP. 1
OEM 37521-VJ525	
<b>SOPORTE CARDAN D22 4X4 (86-94) FRONTIER 2006 / PICKUP (95-97)</b>	
RODAMIENTO : 6206-2RS	
∅ 30 Int.    ⇅ 62 mm    ↔ 16 mm	

<b>COD. 61-20-03N</b>	UN. EMP. 1
OEM 37521-VJ525	
<b>SOPORTE CARDAN D22 4X4 (86-94) FRONTIER 2006/ PICKUP (95-97) - Buje largo</b>	
RODAMIENTO : 6206-2RS	
∅ 30 Int.    ⇅ 62 mm    ↔ 16 mm	

<b>COD. 61-20-07</b>	UN. EMP. 1
OEM 37521-33G25	
<b>SOPORTE CARDAN 4X4 FRONTIER D21 4WD (92...) / D22 (97-02)</b>	
RODAMIENTO : 6206-2RS	
∅ 30 Int.    ⇅ 62 mm    ↔ 16 mm	

<b>COD. 61-20-02</b>	UN. EMP. 1
OEM 37521-F4025	
<b>SOPORTE CARDAN D21 (94)/ PICKUP 2WD 2.4cc (95-03)</b>	
RODAMIENTO : 88508A	
∅ 40 Int.    ⇅ 72 mm    ↔ 17 mm	

<b>COD. 61-20-06</b>	UN. EMP. 1
OEM 37521-W1025	
<b>SOPORTE CARDAN 2WD - NAVARA Y FRONTIER D21 D22 (86...) / DATSUN 1600 (68-91)</b>	
RODAMIENTO : 6206-2RS	
∅ 30 Int.    ⇅ 62 mm    ↔ 16 mm	

<b>COD. 61-20-01</b>	UN. EMP. 1
OEM 37521-01W25	
<b>SOPORTE CARDAN DATSUN 720 PICK UP (79-85)</b>	
RODAMIENTO : 6206-2RS-2RS	
∅ 30 Int.    ⇅ 62 mm    ↔ 16 mm	

## NISSAN

<b>COD. 61-20-04</b>	UN. EMP. 1
<b>SOPORTE CARDAN CABSTAR (05-08)</b>	
RODAMIENTO : 6009-2RS	
∅ 45 Int.    ⇅ 75 mm    ↔ 16 mm	

<b>COD. 61-20-05</b>	UN. EMP. 1
REF. 37512-0T500 / 37521-WJ123	
<b>SOPORTE CARDAN UD41</b>	
RODAMIENTO : 6208-2RS	
∅ Int. 40 mm    ⇅ 80 mm    ↔ 18 mm	

<b>COD. 61-21-01</b>	UN. EMP. 1
OEM 320003602R	
<b>SOPORTE CARDAN RENAULT DUSTER 1.5 1.6 2.0 16V DCI 4X4</b>	
RODAMIENTO : 6206 2RS	
∅ 30 Int.    ⇅ 62 mm    ↔ 16 mm	

## RENAULT

## TOYOTA

<b>COD. 61-24-01</b>	UN. EMP. 1
OEM 37230-0K020	
<b>SOPORTE CARDAN HILUX VIGO 4WD (05...) TACOMA (05-13)</b>	
RODAMIENTO : 6006-2RS	
∅ 30 Int.    ⇅ 55 mm    ↔ 13 mm	

<b>COD. 61-24-02</b>	UN. EMP. 1
OEM 37230-0K040	
<b>SOPORTE CARDAN HILUX 2WD (93-98) / TACOMA (05-13)</b>	
RODAMIENTO : 6206-2RS	
∅ 30 Int.    ⇅ 62 mm    ↔ 16 mm	

<b>COD. 61-24-03</b>	UN. EMP. 1
OEM 37230-35080	
<b>SOPORTE CARDAN HILUX YN106 LN106 (88-99) / 4RUNNER (02-09)</b>	
RODAMIENTO : 6206-2RS	
∅ 30 Int.    ⇅ 62 mm    ↔ 16 mm	

**COD. 61-24-04** UN. EMP. 1  
OEM 37230-35120



**SOPORTE CARDAN T100 TACOMA TUNDRA 2WD (93-04) / HILUX (99-02) / TACOMA VZLA 410**

RODAMIENTO : 6206-2RS  
∅ 30 Int.    ↑ 62 mm    ↔ 16 mm

**COD. 61-24-05** UN. EMP. 1  
OEM 37230-35040/1



**SOPORTE CARDAN STOUT RK110 YK110**

RODAMIENTO : 6206-2RS  
∅ 30 Int.    ↑ 62 mm    ↔ 16 mm

**COD. 61-24-06** UN. EMP. 1  
OEM 37230-36080/1



**SOPORTE CARDAN COASTER RB20 / DYNA RU30**

RODAMIENTO : 6206-2RS  
∅ 30 Int.    ↑ 62 mm    ↔ 16 mm

**COD. 61-24-07** UN. EMP. 1  
OEM 37230-36061



**SOPORTE CARDAN DYNA BU80 BU93 RU30 (84-87)/ DYNA 200 RU85 WU90 YU81 YU82 - Base 78 mm.**

RODAMIENTO : 6206-2RS  
∅ 30 Int.    ↑ 62 mm    ↔ 16 mm

**COD. 61-24-08** UN. EMP. 1  
OEM 37230-35030



**SOPORTE CARDAN HILUX 2WD LN30/40 (79-83) 4WD (98)**

RODAMIENTO : 6006-2rs  
∅ 30 Int.    ↑ 55 mm    ↔ 13 mm

**COD. 61-24-09** UN. EMP. 1  
OEM 37230-42010



**SOPORTE CARDAN TOYOTA RAV**

RODAMIENTO : 6006-2RS  
∅ 30 Int.    ↑ 55 mm    ↔ 13 mm

## CHEVROLET

## DATSUN/SUNNY

**COD. 70-03-01** UN. EMP. 10



**TORNILLO BARRA ESTAB. TROOPER 2 1/2"**

Tornillo: Cabeza Hex. 14 mm  
↔ 69 mm

**COD. 76-00-01** UN. EMP. 5  
REF. 8-94237-365



**TORNILLO COMPENSADOR LUV / ISUZU KB 2.3**

**Sombra**

∅ Ext. 16 mm Rca. Ext. M12x1.25mm  
↔ 81 mm

**COD. 70-20-01** UN. EMP. 10  
OEM 54116-44000



**TORNILLO BARRA ESTAB. DATSUN 1500 - Corta**

∅ Ext. 8.3 mm    ↔ 175 mm

## DATSUN / SUNNY

## HYUNDAI

**COD. 70-20-02** UN. EMP. 10  
OEM 54216-44000



**TORNILLO BARRA ESTAB. DATSUN 1500 - Larga**

∅ Ext. 8.3 mm    ↔ 262 mm

**COD. 70-20-03 /** UN. EMP. 10



**TORNILLO BARRA ESTAB. DATSUN 1200-1600**

∅ Ext. 7 mm    ↔ 130 mm

**COD. 70-09-01** UN. EMP. 5  
OEM 54825-24000



**TORNILLO BARRA ESTAB. EXCEL (89-90)**

∅ 7 mm    ↔ 140 mm

## HYUNDAI

## MAZDA

**COD. 70-09-20 /** UN. EMP. 10  
OEM 5471844000



**TORNILLO BARRA ESTAB. H100 (97...)**

∅ Ext. 8.3 mm    ↔ 18.5 mm

**COD. 70-16-01** UN. EMP. 10



**TORNILLO BARRA ESTAB. MAZDA 323**

∅ 8.3mm    ↔ 146 mm

## TOYOTA

PRODUCTO	COD.	REF.	DESCRIPCION	↔	∅	
	UN. EMP. 5	70-24-03	MT765	TORNILLO BARRA ESTAB. CAMIONETA 3F	210 mm	8.3 mm
		70-24-06	MT766	TORNILLO BARRA ESTAB. CAMPERO 3.8 LTS	210 mm	8.3 mm
		70-24-04	MT763	TORNILLO BARRA ESTAB. CAMIONETA 4.5 LTS.	164 mm	8.3 mm
		70-24-05	MT762	TORNILLO BARRA ESTAB. CAMPERO 4.5 LTS.	175 mm	8.3 mm

**COD. 70-24-01** UN. EMP. 10  
REF. 90101-101404



**TORNILLO BARRA ESTAB.  
HILUX 4WD / 4RUNNER**

∅ 8.3 mm ↔ 175 mm

**COD. 70-24-30** UN. EMP. 10  
REF. 90101-10140



**TORNILLO BARRA ESTAB.  
HILUX 4WD**

∅ 8.3 mm ↔ 175 mm

**COD. 70-24-02** UN. EMP. 10  
REF. 4881935020



**TORNILLO BARRA ESTAB.  
HILUX 2WD (92-99) / 4RUNNER (89-95)**

Hex. 1/2" ↔ 6 1/2" ↔ 160 mm

## TOYOTA

**COD. 70-24-02A** UN. EMP. 10  
REF. 4881935020A



**TORNILLO BARRA ESTAB.  
HILUX 2WD (92-99) / 4RUNNER (89-95)**

Hex 1/2" ↔ 8" ↔ 203 mm

## UNIVERSAL

**COD. 70-00-00** UN. EMP. 10



**TORNILLO BARRA ESTABILIZADORA 2 1/2"**

↔ 69 mm ∅ 9.5 mm

PRODUCTO	COD.	DESCRIPCION	↔	∅	
	UN. EMP. 10	70-00-01	TORNILLO BARRA ESTABILIZADORA 4 1/2"	125 mm	8.3 mm
		70-00-02	TORNILLO BARRA ESTABILIZADORA 5"	147 mm	8.3 mm
		70-00-03	TORNILLO BARRA ESTABILIZADORA 6"	160 mm	8.3 mm

PRODUCTO	COD.	DESCRIPCION	↔	∅	
	UN. EMP. 10	70-00-04	TORNILLO BARRA ESTABILIZADORA 7"	185 mm	8.3 mm
		70-00-05	TORNILLO BARRA ESTABILIZADORA 8"	212 mm	8.3 mm
		70-00-06	TORNILLO BARRA ESTABILIZADORA 9"	250 mm	8.3 mm
		70-00-07	TORNILLO BARRA ESTABILIZADORA 10"	260 mm	8.3 mm

**TORNILLOS BARRA DE TORSION**

<b>COD. 74-03-01</b> OEM 8-94101-707-0	<b>UN. EMP. 2</b>
	
<b>TORNILLO BARRA TORSION LUV / ISUZU 14 mm</b>	
∅ Ext. 14 mm Rca.Ext. M14x1.5 ↔ 141 mm	

<b>COD. 74-03-02</b> OEM 8-94101-707-0	<b>UN. EMP. 2</b>
	
<b>TORNILLO BARRA TORSION LUV 1600 / ISUZU 16 mm</b>	
∅ Ext. 15 mm Rca.Ext. M16x1.5 ↔ 136 mm	

<b>COD. 74-03-03</b> OEM 8-94101-707-0	<b>UN. EMP. 2</b>
	
<b>TORNILLO BARRA TORSION LUV / ISUZU 18 mm</b>	
∅ Ext. 17 mm Rca.Ext. M18x1.5 ↔ 170 mm	

<b>COD. 74-03-04</b>	<b>UN. EMP. 2</b>
	
<b>TORNILLO BARRA TORSION ISUZU / TROOPER 18 mm</b>	
∅ Ext. 17 Rca.Ext. M18x1.5 ↔ 170 mm	

<b>COD. 74-03-05</b>	<b>UN. EMP. 2</b>
	
<b>TORNILLO BARRA TORSION CHEVROLET LUV D-MAX 4X4</b>	
∅ Ext. 16.5 Rca.Ext. M18x1.5 ↔ 166 mm	

<b>COD. 74-09-01</b> OEM 54288-43150	<b>UN. EMP. 2</b>
	
<b>TORNILLO BARRA TORSION H100 / GRAFE</b>	
∅ Ext. 12 mm ↔ 205 mm	

<b>COD. 74-09-02</b> OEM 54288-43150	<b>UN. EMP. 2</b>
	
<b>TORNILLO BARRA TORSION PGR H100</b>	
∅ Ext. 12 mm ↔ 188 mm	

<b>COD. 74-16-01</b> OEM 4839-34-044	<b>UN. EMP. 2</b>
	
<b>TORNILLO BARRA TORSION MAZDA B2000/ B2200</b>	
∅ 12 mm ↔ 127 mm Rosca Ext. M12X1.5	

<b>COD. 74-16-02</b>	<b>UN. EMP. 2</b>
	
<b>TORNILLO BARRA TORSION MAZDA B2600</b>	
∅ 12 mm ↔ 160 mm Rosca Ext. M12x1.5	

<b>COD. 74-16-03</b>	<b>UN. EMP. 2</b>
	
<b>TORNILLO BARRA TORSION MAZDA BT-50</b>	
∅ 12 mm ↔ 160 mm Rosca Ext. M12x1.5	

<b>COD. 74-20-00</b> OEM 54216-31G0A	<b>UND. EMP. 2</b>
	
<b>TORNILLO BARRA TORSION D21 4WD (00-04)</b>	
∅Ext. 12mm ↔ 188mm	

<b>COD. 74-20-01</b> OEM 54216-52G00	<b>UND. EMP. 2</b>
	
<b>TORNILLO BARRA TORSION D21 2WD (98-04)</b>	
∅Ext. 12mm ↔ 152mm	

<b>COD. 74-20-02</b>	<b>UN. EMP. 2</b>
	
<b>TORNILLO BARRA TORSION NISSAN DATSUN 1500</b>	
∅ Ext. 11 mm ↔ 186 mm	

<b>COD. 74-20-03</b>	<b>UN. EMP. 2</b>
	
<b>TORNILLO BARRA TORSION NISSAN DATSUN 1500/TUERC</b>	
∅ Ext. 18 mm ↔ 115 mm	

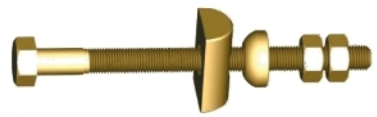
<b>COD. 74-20-04</b> OEM	<b>UN. EMP. 2</b>
	
<b>TORNILLO BARRA TORSION FRONTIER (06-13)</b>	
∅ Ext. 14 mm ↔ 190 mm	

<b>COD. 74-24-01</b> OEM 9010112104	<b>UN. EMP. 2</b>
	
<b>TORNILLO BARRA TORSION HILUX 2WD (84-95)</b>	
∅ Ext. 12 mm ↔ 188 mm	

<b>COD. 74-24-02</b> OEM 90107-12159	<b>UN. EMP. 2</b>
	
<b>TORNILLO BARRA TORSION HILUX 4WD (92-99)</b>	
∅ Ext. 12 mm ↔ 205 mm	

<b>COD. 74-24-03</b>	<b>UN. EMP. 2</b>
	
<b>TORNILLO BARRA TORSION TACOMA</b>	
∅ Ext. 12 mm ↔ 205 mm	

<b>COD. 74-24-04</b> OEM 4816926060	<b>UN. EMP. 2</b>
	
<b>TORNILLO BARRA TORSION HIACE (99-05)</b>	
∅ Ext. 12 mm ↔ 188 mm	

## CHEVROLET

<b>COD. 70-03-03</b>	UN. EMP. 1
REF. 71269	
<b>VAR. BARRA ESTAB. DEL. AVEO (04-10)</b>	
DISTANCIA ENTRE CENTROS	260 mm
BOLA	10 mm

<b>COD. 70-03-04</b>	UN. EMP. 1
OEM 42420-60A00 / REF. 22165	
<b>VAR. BARRA ESTAB. ESTEEM / SWIFT</b>	
DISTANCIA ENTRE CENTROS	67 mm
BOLA	10 mm

<b>COD. 70-03-05</b>	UN. EMP. 1
<b>VAR. BARRA ESTAB. DEL. CORSA EVOLUTION - L/R</b>	
DISTANCIA ENTRE CENTROS	67 mm
BOLA	10 mm

<b>COD. 70-03-07</b>	UN. EMP. 1
OEM 8979445750 / REF. 14026 / 187020	
<b>VAR. ESTAB. DEL. DMAX 2WD</b>	
DISTANCIA ENTRE CENTROS	121 mm
BOLA	10 mm

<b>COD. 70-03-08</b>	UN. EMP. 1
OEM 8979445680 / REF.14027 / 187021	
<b>VAR. ESTAB. DEL. DMAX 4WD-R</b>	
DISTANCIA ENTRE CENTROS	155 mm
BOLA	10 mm

<b>COD. 70-03-09</b>	UN. EMP. 1
OEM 8979445680 / REF. 14028 / 187022	
<b>VAR. ESTAB. DEL. DMAX 4WD-L</b>	
DISTANCIA ENTRE CENTROS	155 mm
BOLA	10 mm

<b>COD. 70-03-10</b>	UN. EMP. 1
REF. 71271	
<b>VAR. ESTAB. DEL. OPTRA 1800 cc - L/R</b>	
DISTANCIA ENTRE CENTROS	265 mm
BOLA	10 mm

<b>COD. 70-03-11</b>	UN. EMP. 1
REF. 71272	
<b>VAR. ESTAB. TRAS. OPTRA - L/R</b>	
DISTANCIA ENTRE CENTROS	220 mm
BOLA	10 mm

<b>COD. 70-03-12</b>	UN. EMP. 1
REF. 14008/15010	
<b>VAR. ESTAB. STEEM TRAS ( R )</b>	
DISTANCIA ENTRE CENTROS	174 mm
BOLA	10 mm

<b>COD. 70-03-13</b>	UN. EMP. 1
REF. 14009/15011	
<b>VAR. ESTAB. STEEM TRAS ( L )</b>	
DISTANCIA ENTRE CENTROS	174 mm
BOLA	10 mm

<b>COD. 70-03-14</b>	UN. EMP. 1
OEM 96057649 / REF. 14013 / 71235	
<b>VAR. ESTAB. DEL. TRACKER / SUZUKI / VITARA (99-04)</b>	
DISTANCIA ENTRE CENTROS	76 mm
BOLA	10mm

<b>COD. 70-03-15</b>	UN. EMP. 1
<b>VAR. ESTAB. ISUZU TROOPER 960 DEL ( R )</b>	
DISTANCIA ENTRE CENTROS	150 mm
BOLA	10 mm

<b>COD. 70-03-16</b>	UN. EMP. 1
<b>VAR. ESTAB. ISUZU TROOPER 960 DEL ( L )</b>	
DISTANCIA ENTRE CENTROS	150 mm
BOLA	10 mm

<b>COD. 70-03-17</b>	UN. EMP. 1
REF. 02M931 / PNXXX	
<b>VAR. ESTAB. CHEVROLET N-200 Y CHANA</b>	
DISTANCIA ENTRE CENTROS	120 mm
BOLA	10 mm

<b>COD. 70-23-03</b>	UN. EMP. 1
REF. 71276	
<b>VAR. ESTAB. DEL. SZ 4WD GRAND VITARA 09 -R/L</b>	
DISTANCIA ENTRE CENTROS	297 mm
BOLA	10 mm

## FORD

<b>COD. 70-08-01</b>	UN. EMP. 1
REF. 71400/14480	
<b>VAR. ESTAB. DEL. ECOSPORT -L/R</b>	
DISTANCIA ENTRE CENTROS	248 mm
BOLA	10 mm

<b>COD. 70-08-02</b>	UN. EMP. 1
REF. 71400/14481	
<b>VAR. ESTAB. TRAS. ECOSPORT 4WD -L/R</b>	
DISTANCIA ENTRE CENTROS	118 mm
BOLA	10 mm

<b>COD. 70-28-01</b>	UN. EMP. 1
REF. 52320-S9A-003	
<b>VAR. ESTAB. TRAS. CIVIC / CRV (01-06) -R</b>	
DISTANCIA ENTRE CENTROS	88 mm
BOLA	10 mm

## HONDA







### HONDA

<p><b>COD. 70-28-02</b> UN. EMP. 1 REF. 52321-S9A-003</p>  <p style="text-align: center;"><b>VAR. ESTAB. TRAS. CIVIC / CRV (01-06) -L</b></p> <p>DISTANCIA ENTRE CENTROS 88 mm BOLA 10 mm</p>	<p><b>COD. 70-28-03</b> UN. EMP. 1 REF. 52320-S5A-003</p>  <p style="text-align: center;"><b>VAR. ESTAB. DEL. CIVIC (02-06) / CRV (00-05) -R</b></p> <p>DISTANCIA ENTRE CENTROS 55 mm BOLA 10 mm</p>	<p><b>COD. 70-28-04</b> UN. EMP. 1 REF. 52320-S9A-003</p>  <p style="text-align: center;"><b>VAR. ESTAB. TRAS. CIVIC (02-06) / CRV (00-05) -L</b></p> <p>DISTANCIA ENTRE CENTROS 55 mm BOLA 10 mm</p>
<p><b>COD. 70-28-05</b> UN. EMP. 1</p>  <p style="text-align: center;"><b>TAB. DEL. CRV (98...) -L/R</b></p> <p>DISTANCIA ENTRE CENTROS 60 mm BOLA 10 mm</p>	<p><b>COD. 70-28-06</b> UN. EMP. 1</p>  <p style="text-align: center;"><b>VAR. ESTAB. TRAS. CRV (98...) -L</b></p> <p>DISTANCIA ENTRE CENTROS 127 mm BOLA 10 mm</p>	<p><b>COD. 70-28-07</b> UN. EMP. 1</p>  <p style="text-align: center;"><b>VAR. ESTAB. TRAS. CRV (98...) -R</b></p> <p>DISTANCIA ENTRE CENTROS 127 mm BOLA 10 mm</p>

### HONDA

<p><b>COD. 70-28-10</b> UN. EMP. 1 REF. ERO833MO</p>  <p style="text-align: center;"><b>TAB. DEL. CIVIC (06-10) -R</b></p> <p>DISTANCIA ENTRE CENTROS 69 mm BOLA 10 mm</p>	<p><b>COD. 70-28-11</b> UN. EMP. 1 REF. ERO833MO</p>  <p style="text-align: center;"><b>VAR. ESTAB. DEL. CIVIC (06-10) -L</b></p> <p>DISTANCIA ENTRE CENTROS 69 mm BOLA 10 mm</p>	<p><b>COD. 70-09-02</b> UN. EMP. 1 OEM 54830-25020 / REF. 43041</p>  <p style="text-align: center;"><b>VAR. ESTAB. DEL. ACCENT (00...)/ VERNA (00-03) -R</b></p> <p>DISTANCIA ENTRE CENTROS 60 mm BOLA 10 mm</p>
---	--	---

### HYUNDAI

<p><b>COD. 70-09-03</b> UN. EMP. 1 OEM 54830-25010 / REF. 43042</p>  <p style="text-align: center;"><b>VAR. ESTAB. DEL. ACCENT (00...)/ VERNA (00-03) -L</b></p> <p>DISTANCIA ENTRE CENTROS 60 mm BOLA 10 mm</p>	<p><b>COD. 70-09-04</b> UN. EMP. 1 REF. 43043</p>  <p style="text-align: center;"><b>VAR. ESTAB. TRAS. VERNA -L/R</b></p> <p>DISTANCIA ENTRE CENTROS 122 mm BOLA 10 mm</p>	<p><b>COD. 70-09-05</b> UN. EMP. 1 OEM 54830-25020 / REF. 43048</p>  <p style="text-align: center;"><b>VAR. ESTAB. DEL. ACCENT GYRO -R</b></p> <p>DISTANCIA ENTRE CENTROS 60 mm BOLA 10 mm</p>
<p><b>COD. 70-09-06</b> UN. EMP. 1 OEM 54830-25010 / REF. 43049</p>  <p style="text-align: center;"><b>VAR. ESTAB. DEL. ACCENT GYRO -L</b></p> <p>DISTANCIA ENTRE CENTROS 60 mm BOLA 10 mm</p>	<p><b>COD. 70-09-07</b> UN. EMP. 1 REF. 43050 / OEM 54830-4A000</p>  <p style="text-align: center;"><b>VAR. ESTAB. DEL. STAREX (96-02) -L/R</b></p> <p>DISTANCIA ENTRE CENTROS 60 mm BOLA 12 mm</p>	<p><b>COD. 70-09-10</b> UN. EMP. 1 OEM 54830-34500</p>  <p style="text-align: center;"><b>VAR. ESTAB. DEL. ELANTRA (00-06) -L/R</b></p> <p>DISTANCIA ENTRE CENTROS 70 mm BOLA 10 mm</p>

<b>COD. 70-09-11</b>	UN. EMP. 1
OEM K7251	
	
<b>VAR. ESTAB. DEL. EAGLE VISION (93-97) -L</b>	
DISTANCIA ENTRE CENTROS	280 mm
BOLA	10 mm

<b>COD. 70-09-12</b>	UN. EMP. 1
OEM K7251	
	
<b>VAR. ESTAB. DEL. EAGLE VISION (93-97) -R</b>	
DISTANCIA ENTRE CENTROS	280 mm
BOLA	10 mm

<b>COD. 70-09-13</b>	UN. EMP. 1
OEM 54830-2H000	
	
<b>VAR. ESTAB. DEL. AVANTE (ELANTRA) (06-10)</b>	
DISTANCIA ENTRE CENTROS	127 mm
BOLA	10 mm

<b>COD. 70-09-14</b>	UN. EMP. 1
OEM 54830-34500	
	
<b>VAR. ESTAB. DEL. ELANTRA 2000/ SONATA 2.3</b>	
DISTANCIA ENTRE CENTROS	64 mm
BOLA	10 mm

<b>COD. 70-09-16</b>	UN. EMP. 1
REF. 54820-02000	
	
<b>VAR. ESTAB. DEL. ATOS (R - L)</b>	
DISTANCIA ENTRE CENTROS	68 mm
BOLA	10 mm

<b>COD. 70-09-17</b>	UN. EMP. 1
REF. 54830 / 2H000 / 2H100 / 2H200	
	
<b>VAR. ESTAB. ELANTRA 2006... KIA CERATO / FORTE 2L 2009...</b>	
DISTANCIA ENTRE CENTROS	240 mm
BOLA	12 mm

## KIA

<b>COD. 70-12-01</b>	UN. EMP. 1
OEM 54820FD000 / 71242	
	
<b>VARILLA ESTAB. DEL. KIA RIO (03-05) -L</b>	
DISTANCIA ENTRE CENTROS	215 mm
BOLA	10 mm

<b>COD. 70-12-02</b>	UN. EMP. 1
OEM 54830FD000 / 71241	
	
<b>VARILLA ESTAB. DEL. KIA RIO (03-05) -R</b>	
DISTANCIA ENTRE CENTROS	215 mm
BOLA	10 mm

<b>COD. 70-12-03</b>	UN. EMP. 1
OEM 0K2A5-34-150A	
	
<b>VARILLA ESTAB. DEL. KIA SEPHIA II (96-97) -L/R</b>	
DISTANCIA ENTRE CENTROS	90 mm
BOLA	10 mm

<b>COD. 70-12-04</b>	UN. EMP. 1
	
<b>VARILLA ESTAB. TRAS. KIA RIO</b>	
DISTANCIA ENTRE CENTROS	170 mm
BOLA	10 mm

<b>COD. 70-12-05</b>	UN. EMP. 1
	
<b>VARILLA ESTAB. DEL. KIA RIO (M/N)</b>	
DISTANCIA ENTRE CENTROS	215 mm
BOLA	10 mm

<b>COD. 70-12-06</b>	UN. EMP. 1
OEM 54830-07000	
	
<b>VARILLA ESTAB. DEL. KIA PICANTO (04) -L/R</b>	
DISTANCIA ENTRE CENTROS	230 mm
BOLA	10 mm

## MAZDA

<b>COD. 70-16-02</b>	UN. EMP. 1
REF. 24012/15102	
	
<b>VAR. ESTAB. MAZDA ALLEGRO M.V. DEL ( R )</b>	
DISTANCIA ENTRE CENTROS	104 mm
BOLA	10 mm

<b>COD. 70-16-03</b>	UN. EMP. 1
REF. 24013/1510353458	
	
<b>VAR. ESTAB. MAZDA ALLEGRO M.V. DEL ( L )</b>	
DISTANCIA ENTRE CENTROS	104 mm
BOLA	10 mm

<b>COD. 70-16-04</b>	UN. EMP. 1
OEM 53410	
	
<b>VAR. ESTAB. DEL. MAZDA MATSURI-R</b>	
DISTANCIA ENTRE CENTROS	103 mm
BOLA	10 mm

<b>COD. 70-16-05</b>	UN. EMP. 1
OEM 53420	
	
<b>VAR. ESTAB. DEL. MAZDA MATSURI -L</b>	
DISTANCIA ENTRE CENTROS	103 mm
BOLA	10 mm

<b>COD. 70-16-06</b>	UN. EMP. 1
OEM 53453	
	
<b>VAR. ESTAB. DEL. MAZDA ALLEGRO 1.6 (MN)-L/R</b>	
DISTANCIA ENTRE CENTROS	260 mm
BOLA	10 mm

<b>COD. 70-16-07</b>	UN. EMP. 1
OEM 53451	
	
<b>VAR. ESTAB. TRAS. MAZDA ALLEGRO 1.6 (MN)-L/R</b>	
DISTANCIA ENTRE CENTROS	160 mm
BOLA	10 mm

COD. 70-16-08	UN. EMP. 1
OEM 53430	
<b>VAR. ESTAB. TRAS. MAZDA ALLEGRO 1.6 (MV)</b>	
DISTANCIA ENTRE CENTROS	190 mm
BOLA	10 mm

COD. 70-16-09	UN. EMP. 1
OEM 53440	
<b>VAR. ESTAB. TRAS. MAZDA MATSURI</b>	
DISTANCIA ENTRE CENTROS	90 mm
BOLA	10 mm

COD. 70-16-10	UN. EMP. 1
OEM GA2A-34-150 / 53454	
<b>VAR. ESTAB. DEL. MAZDA 626 MILENIUM MAZDA 626 (93-97) / MAZDA 323 (95-98) -R</b>	
DISTANCIA ENTRE CENTROS	105 mm
BOLA	10 mm

COD. 70-16-11	UN. EMP. 1
OEM GA2A-34-170A / 53457	
<b>VAR. ESTAB. DEL. MAZDA 626 MILENIUM MAZDA 626 (93-97) / MAZDA 323 (95-98) -L</b>	
DISTANCIA ENTRE CENTROS	105 mm
BOLA	10 mm

COD. 70-16-12	UN. EMP. 1
<b>VAR. ESTAB. TRAS. MAZDA 626 MILENIUM -L/R</b>	
DISTANCIA ENTRE CENTROS	250 mm
BOLA	10 mm

COD. 70-16-13	UN. EMP. 1
CE 2113001 / REF. 53400	
<b>VAR. ESTAB. DEL. MAZDA 3 (03-09) MAZDA 5 (03-09) -L/R</b>	
DISTANCIA ENTRE CENTROS	305 mm
BOLA	10 mm

COD. 70-16-14	UN. EMP. 1
REF. 53401	
<b>VAR. ESTAB. TRAS. MAZDA 3 -L/R</b>	
DISTANCIA ENTRE CENTROS	47 mm
BOLA	10 mm

COD. 70-16-15	UN. EMP. 1
REF. 53461	
<b>VAR. ESTAB. DEL. MAZDA 6 (03-08) -R</b>	
DISTANCIA ENTRE CENTROS	155 mm
BOLA	10 mm

COD. 70-16-16	UN. EMP. 1
REF. 53462	
<b>VAR. ESTAB. DEL. MAZDA 6 (03-08) -L</b>	
DISTANCIA ENTRE CENTROS	155 mm
BOLA	10 mm

COD. 70-16-17	UN. EMP. 1
REF. 53463	
<b>VAR. ESTAB. TRAS. MAZDA 6 (03-08)</b>	
DISTANCIA ENTRE CENTROS	75 mm
BOLA	10 mm

COD. 70-16-18	UN. EMP. 1
OEM 24012 / 15102	
<b>VAR. ESTAB. DEL. MAZDA 323 MV -R</b>	
DISTANCIA ENTRE CENTROS	104 mm
BOLA	10 mm

COD. 70-16-19	UN. EMP. 1
OEM 24013 / 15103 53458	
<b>VAR. ESTAB. DEL. MAZDA 323 MV -L</b>	
DISTANCIA ENTRE CENTROS	104 mm
BOLA	10 mm

### MITSUBISHI

COD. 70-19-04	UN. EMP. 1
<b>VAR. ESTAB. DEL. MITSUBISHI LANCER</b>	
DISTANCIA ENTRE CENTROS	76,5 mm
BOLA	10 mm

COD. 70-19-05	UN. EMP. 1
<b>VAR. ESTAB. DEL. MITSUBISHI LANCER (94)</b>	
DISTANCIA ENTRE CENTROS	52,5 mm
BOLA	10 mm

COD. 70-19-07	UN. EMP. 1
REF. 984001	
<b>VARILLA BARRA ESTAB. MITSUBISHI CANTER FUSO</b>	
DISTANCIA ENTRE CENTROS	159 mm
BOLA	12 mm

### NISSAN

COD. 70-20-04	UN. EMP. 1
REF. 15317/75132	
<b>VAR. ESTAB. DEL. NISSAN MT300</b>	
DISTANCIA ENTRE CENTROS	136 mm
BOLA	12 mm

COD. 70-20-05	UN. EMP. 1
REF. 74008/15307/75126	
<b>VAR. ESTAB. DEL. PATHFINDER (96-04)</b>	
DISTANCIA ENTRE CENTROS	189 mm
BOLA	12 mm

COD. 70-20-06	UN. EMP. 1
OEM 56260-2W100	
REF. 74009 / 15315 / 75133	
<b>VAR. ESTAB. TRAS. PATHFINDER 2WD (96-04) - L/R</b>	
DISTANCIA ENTRE CENTROS	200 mm
BOLA	10 mm

<b>COD. 70-20-07</b>	UN. EMP. 1
OEM 54618-D5010	
<b>VAR. ESTAB. DEL . NISSAN SENTRA -L/R</b> <b>B12 (89-92) / B13 (93-98) / PATROL (85-92)</b>	
DISTANCIA ENTRE CENTROS	73 mm

<b>COD. 70-20-08</b>	UN. EMP. 1
OEM 54618-D5010-8	
<b>VAR. ESTAB. TRAS . NISSAN SENTRA</b>	
DISTANCIA ENTRE CENTROS	160 mm
BOLA	10 mm

<b>COD. 70-20-09</b>	UN. EMP. 1
OEM 54618-D5010	
<b>VAR. ESTAB. DEL . NISSAN SENTRA -L/R</b> <b>B12 (89-92) / B13 (93-98) / B14</b>	
DISTANCIA ENTRE CENTROS	73 mm
BOLA	10 mm

<b>COD. 70-20-10</b>	UN. EMP. 1
OEM 74011 / 15311	
<b>VAR. ESTAB. TRAS . NISSAN SENTRA B14</b>	
DISTANCIA ENTRE CENTROS	150 mm
BOLA	10 mm

<b>COD. 70-20-11</b>	UN. EMP. 1
OEM 75125	
<b>VAR. ESTAB. TRAS . NISSAN SENTRA B14</b>	
DISTANCIA ENTRE CENTROS	160 mm
BOLA	10 mm

<b>COD. 70-20-12</b>	UN. EMP. 1
REF. 54618-47000	
<b>VAR. ESTAB. DEL . NISSAN SENTRA -L/R</b> <b>B14 (95-99)</b>	
DISTANCIA ENTRE CENTROS	73 mm
BOLA	10 mm

<b>COD. 70-20-13</b>	UN. EMP. 1
OEM 54618-50Y00	
<b>VAR. ESTAB. DEL . NISSAN URVAN (90-95)</b>	
DISTANCIA ENTRE CENTROS	86 mm
BOLA	10 mm

<b>COD. 70-20-14</b>	UN. EMP. 1
OEM 54618-F3901	
<b>VAR. ESTAB. DEL. NISSAN CABSTAR (00) -L/R</b>	
DISTANCIA ENTRE CENTROS	196,5 mm
BOLA	12 mm

<b>COD. 70-20-15</b>	UN. EMP. 1
OEM 54668EA000 / REF. 5-K80470	
<b>VAR. ESTAB. DEL. FRONTIER /</b> <b>NAVARA 4WD (05-13) -L</b>	
DISTANCIA ENTRE CENTROS	66 mm
BOLA	20 mm

## NISSAN

## PEUGEOUT

## RENAULT

<b>COD. 70-20-16</b>	UN. EMP. 1
OEM 54618EA000 / REF. 5-K80471	
<b>VAR. ESTAB. DEL. FRONTIER /</b> <b>NAVARA 4WD (05-13) -R</b>	
DISTANCIA ENTRE CENTROS	66 mm
BOLA	20 mm

<b>COD. 70-35-01</b>	UN. EMP. 1
OEM 5087.45 / 5087.59 / 5087.66	
<b>VAR. ESTAB. DEL. PEUGEOT 206 (01-14) /</b> <b>CITROEN C3 (02-14)</b>	
DISTANCIA ENTRE CENTROS	335 mm
BOLA	10 mm

<b>COD. 70-21-01</b>	UN. EMP. 1
<b>VAR. ESTAB. DEL. TWINGO II -R</b>	
DISTANCIA ENTRE CENTROS	259 mm
BOLA	10 mm

## RENAULT

## TOYOTA

<b>COD. 70-21-02</b>	UN. EMP. 1
<b>VAR. ESTAB. DEL. TWINGO II -L</b>	
DISTANCIA ENTRE CENTROS	259 mm
BOLA	10 mm

<b>COD. 70-24-07</b>	UN. EMP. 1
OEM 48820-AD	
<b>VAR. ESTAB. DEL. PRADO / RUNNER -L/R</b>	
DISTANCIA ENTRE CENTROS	165 mm
BOLA	12 mm

<b>COD. 70-24-08</b>	UN. EMP. 1
REF. 71224	
<b>VAR. ESTAB. TRAS. PRADO / RUNNER -L/R</b>	
DISTANCIA ENTRE CENTROS	135 mm
BOLA	12 mm

<b>COD. 70-24-09</b>	UN. EMP. 1
OEM 48830-20010	
<b>VAR. ESTAB. TRAS. COROLLA (88-) -L/R</b>	
DISTANCIA ENTRE CENTROS	105 mm
BOLA	10 mm

<b>COD. 70-24-10</b>	UN. EMP. 1
OEM 48820-20010	
<b>VAR. ESTAB. DEL. COROLLA (87-90) -L/R</b>	
DISTANCIA ENTRE CENTROS	66 mm
BOLA	10 mm

<b>COD. 70-24-11</b>	UN. EMP. 1
<b>VAR. ESTAB. DEL. COROLLA (91) -L/R</b>	
DISTANCIA ENTRE CENTROS	88 mm
BOLA	10 mm

## VARILLA BARRA ESTABILIZADORA

<p><b>COD. 70-24-12</b> UN. EMP. 1</p>  <p><b>VAR. ESTAB. TRAS. COROLLA (88) -L/R</b></p> <p>DISTANCIA ENTRE CENTROS 58 mm BOLA 10 mm</p>	<p><b>COD. 70-24-14</b> UN. EMP. 1</p> <p>OEM 48820-42020 / 48820-32020</p>  <p><b>VAR. ESTAB. DEL. RAV 4 (01-06) / COROLLA (03-05) -L/R</b></p> <p>DISTANCIA ENTRE CENTROS 285 mm BOLA 10 mm</p>	<p><b>COD. 70-24-16</b> UN. EMP. 1</p> <p>OEM 48830-42010</p>  <p><b>VAR. ESTAB. TRAS. RAV 4 (01-06) -R</b></p> <p>DISTANCIA ENTRE CENTROS 100 mm BOLA 12 mm</p>
<p><b>COD. 70-24-17</b> UN. EMP. 1</p> <p>OEM 48840-42010</p>  <p><b>VAR. ESTAB. TRAS. RAV 4 (01-06) -L</b></p> <p>DISTANCIA ENTRE CENTROS 100 mm BOLA 12 mm</p>	<p><b>COD. 70-24-18</b> UN. EMP. 1</p> <p>OEM 48820-0K030</p>  <p><b>VAR. ESTAB. DEL. HILUX VIGO (04-07) PRADO 4WD (04-05) -R</b></p> <p>DISTANCIA ENTRE CENTROS 145 mm BOLA 22 mm</p>	<p><b>COD. 70-24-19</b> UN. EMP. 1</p> <p>OEM 48810-0K010</p>  <p><b>VAR. ESTAB. DEL. HILUX VIGO (04-07) PRADO 4WD (04-05) -L</b></p> <p>DISTANCIA ENTRE CENTROS 145 mm BOLA 22 mm</p>
<p><b>COD. 70-24-31</b> UN. EMP. 1</p> <p>OEM: 29030556</p>  <p><b>VAR. ESTAB. DEL. TACOMA 4X4 95-00 L/R</b></p> <p>DISTANCIA ENTRE CENTROS 103 mm BOLA 19mm</p>	<p><b>COD. 70-24-32</b> UN. EMP. 1</p> <p>OEM:</p>  <p><b>VAR. ESTAB. 4 RUNNER 96-02</b></p> <p>DISTANCIA ENTRE CENTROS 175 mm BOLA 19mm</p>	

## ZAPAS

COD. 63-27-01  
REF. A050

UN. EMP. 1



ZAPA WILLYS - Con buje liso

COD. 63-27-02

UN. EMP. 1



ZAPA WILLYS - Con buje rosca

COD. 63-27-03  
REF. A051

UN. EMP. 1



ZAPA WILLYS - Hueco de 7/16" (A05)

COD. 63-27-04  
REF. A051A

UN. EMP. 1



ZAPA WILLYS - Hueco de 9/16"

COD. 63-27-05  
REF. A051B

UN. EMP. 1



ZAPA WILLYS - Hueco de 5/8"

## CONOS DE EJE

PRODUCTO	COD.	DESCRIPCION	∅ Int.	∅ Ext.	↔
UN. EMP. 50	22-00-00A	CONO DE EJE DE 5/16"	3.95 mm	7.15 mm	8mm
	22-00-00	CONO DE EJE DE 3/8"	4.75 mm	8.95 mm	9.1 mm
	22-00-01	CONO DE EJE DE 7/16"	5.55 mm	9.5 mm	10 mm
	22-00-02	CONO DE EJE DE 1/2"	6.35 mm	10.3 mm	106 mm
	22-00-03	CONO DE EJE DE 9/16"	7.15 mm	10.3 mm	10.5mm
	22-00-04	CONO DE EJE DE 5/8"	7.95 mm	11.9 mm	10.5 mm
	22-00-05	CONO DE EJE DE 3/4"	9.52 mm	12.7 mm	12.7 mm

## GRAPAS CRUCETA

PRODUCTO	COD.	DESCRIPCIÓN	UN. EMP.
	25-08-01	GRAPA CRUCETA JEEP F100-350 (5/16" Corta)	10
	25-08-02	GRAPA CRUCETA JEEP F100-350 (5/16" Larga)	10
	25-00-02	GRAPA CRUCETA F600 (3/8" Corta)	10
	25-00-03	GRAPA CRUCETA F600 (3/8" Larga)	10
	25-00-01	GRAPA CRUCETA F600 (7/16")	10

## PINES

COD. 53-00-01

UN. EMP. 100



PIN PARA BANDA PEQUEÑO

COD. 53-00-02

UN. EMP. 100



PIN PARA BANDA MEDIANO

COD. 53-00-03

UN. EMP. 50



PIN PARA BANDA GRANDE

COD. 54-00-02

UN. EMP. 20



PIN CRUCETA CAMION F800 - PC2

COD. 54-00-04

UN. EMP. 20



PIN CRUCETA CAMION HI RI 90 - PC4

PRODUCTO	COD.	DESCRIPCION	∅ Int.	↔ (mm)	
	UN. EMP. 20	54-00-03	PIN CRUCETA CAMION MACK DTROQUE P900 - PC3	10 mm	78.5 mm
		54-00-05	PIN CRUCETA MACK/ KODIAK/ HI (MN) 5"-R600	8 mm	75 mm
		54-00-06	PIN CRUCETA KODIAK 3/8"	9.5 mm	75 mm
		54-00-07	PIN DTROQUE / TRACTOMULA - TC900	10 mm	90 mm
		54-00-08	PIN CRUCETA PARA 15 1/2"	11 mm	82 mm

## ***GARANTÍA DE FÁBRICA***

La garantía es procedente para las líneas de autopartes ASAM SAS cuando el producto o la pieza presenta fallas o alteraciones de sus funciones provocadas SOLAMENTE por defecto del material o de fabricación, dentro de los 2 meses siguientes a partir de la fecha de facturación y comprende el cambio del repuesto.

ASAM SAS no se hace responsable por garantías si el producto:

- \* Está fuera de los plazos de garantía
- \* Ha sido almacenado inadecuadamente.
- \* Ha sido utilizado indebidamente (instalación incorrecta, mal uso).
- \* Se ha utilizado para aplicaciones fuera de las especificaciones (adaptaciones).
- \* Problemas externos.

En **AUTOPARTES**  
nuestro respaldo,  
su tranquilidad.





## CONTÁCTANOS:

Móvil: (57) 310 814 8858

(57) 310 875 4183

Email: [comercial@asam.com.co](mailto:comercial@asam.com.co)

[www.asam.com.co](http://www.asam.com.co)

